



HYUNDAI U-Series  
**Magnetic Contactor**  
**| Overload Relay**

# for YOU and being NEW HYUNDAI U-Series Magnetic Contactor & Overload Relay

The word U represents  
You, our business partner and  
New, your latest needs.

UMC magnetic contactor series employ a modular design which allows quick and simple mounting of auxiliary contact blocks, timers, mechanical latching blocks, etc. It provides convenience, economic benefit and high reliability.

Featuring superior design for industrial applications such as motor control centers, U-Series contactor and relay can be used for various control systems, and favored by shipyards and power plants where high reliability and performance are the critical criteria.



## CONTENTS

Features 4 · Contactor & Control Relay 9 · Thermal Overload Relay 49  
Dimensions 58 · Installation 70 · Precautions 71

## Upgrade your Electric Systems with U-Series Contactor and Relay



## Features



### Connection

■ Screw type : 9-800A

■ Lug type : 40-100A



### 35mm DIN-rail installation up to 100AF

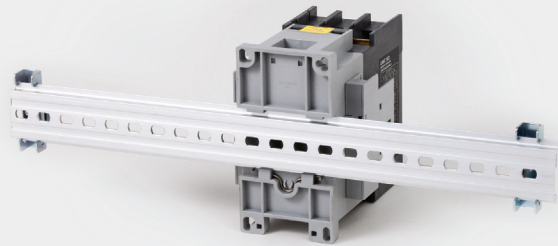

### Safety cover - IP20

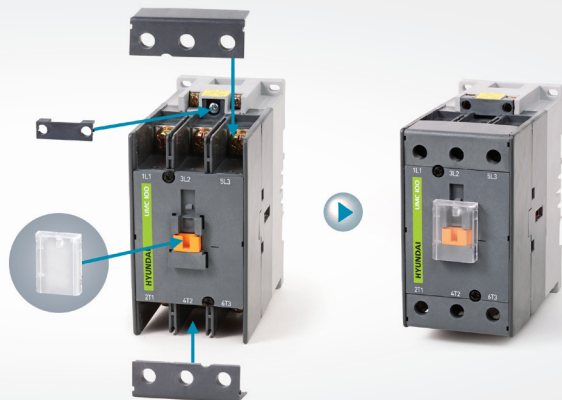

## Easy coil replacement

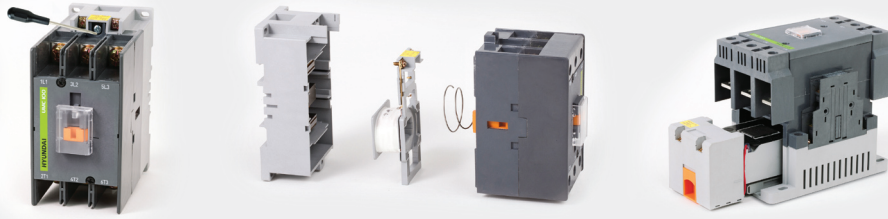

## Convenient main contact inspection

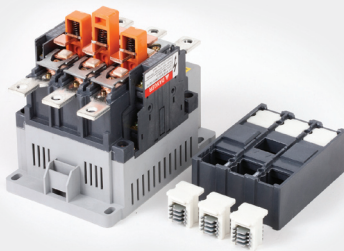

## Light-weight by engineering plastic

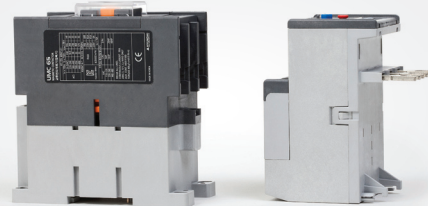

## Optimized arc grid

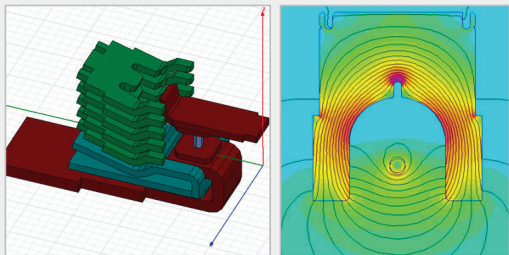

## CB certified by KERI (IEC60947-4-1)



## Noise free & free voltage by DC exciting method (115-800A)

## Features

### Ampere Frame

#### 12AF



**UMC9,12**  
 ■ Rated current 9, 12A  
 ■ Rated insulation voltage 750V



**UTH12**  
 ■ Current range 0.12-12A

#### 32AF



**UMC18, 25, 32**  
 ■ Rated current 18, 25, 32A  
 ■ Rated insulation voltage 750V



**UTH32**  
 ■ Current range 0.12-32A

#### 65AF



**UMC40, 50, 65**  
 ■ Rated current 40, 50, 65A  
 ■ Rated insulation voltage 750V



**UTH65**  
 ■ Current range 7-65A

#### 100AF



**UMC75, 85, 100**  
 ■ Rated current 75, 85, 100A  
 ■ Rated insulation voltage 750V



**UTH100**  
 ■ Current range 17-100A

#### 150AF



**UMC115, 130, 150**  
 ■ Rated current 115, 130, 150A  
 ■ Rated insulation voltage 1000V



**UTH150**  
 ■ Current range 48-150A

#### 265AF



**UMC185, 225, 265**  
 ■ Rated current 185, 225, 265A  
 ■ Rated insulation voltage 1000V

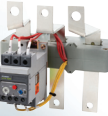

**UTH265**  
 ■ Current range 48-265A

#### 500AF



**UMC300, 400, 500**  
 ■ Rated current 300, 400, 500A  
 ■ Rated insulation voltage 1000V

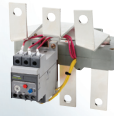

**UTH400**  
 ■ Current range 90-400A  
**UTH800**  
 ■ Current range 300-500A

#### 800AF



**UMC630, 800**  
 ■ Rated current 630, 800A  
 ■ Rated insulation voltage 1000V

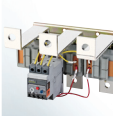

**UTH800**  
 ■ Current range 378-800A

### External Structure

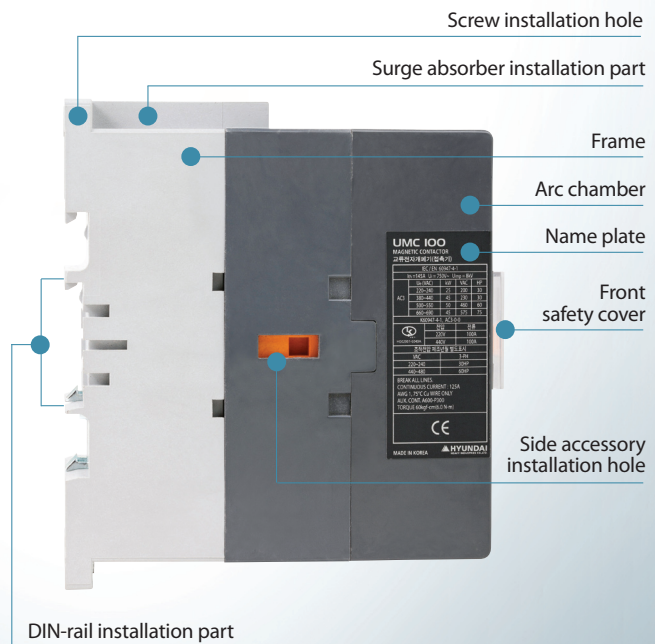
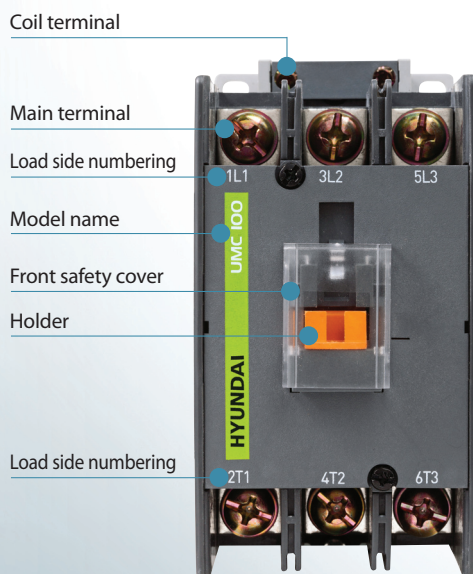

## Internal Structure

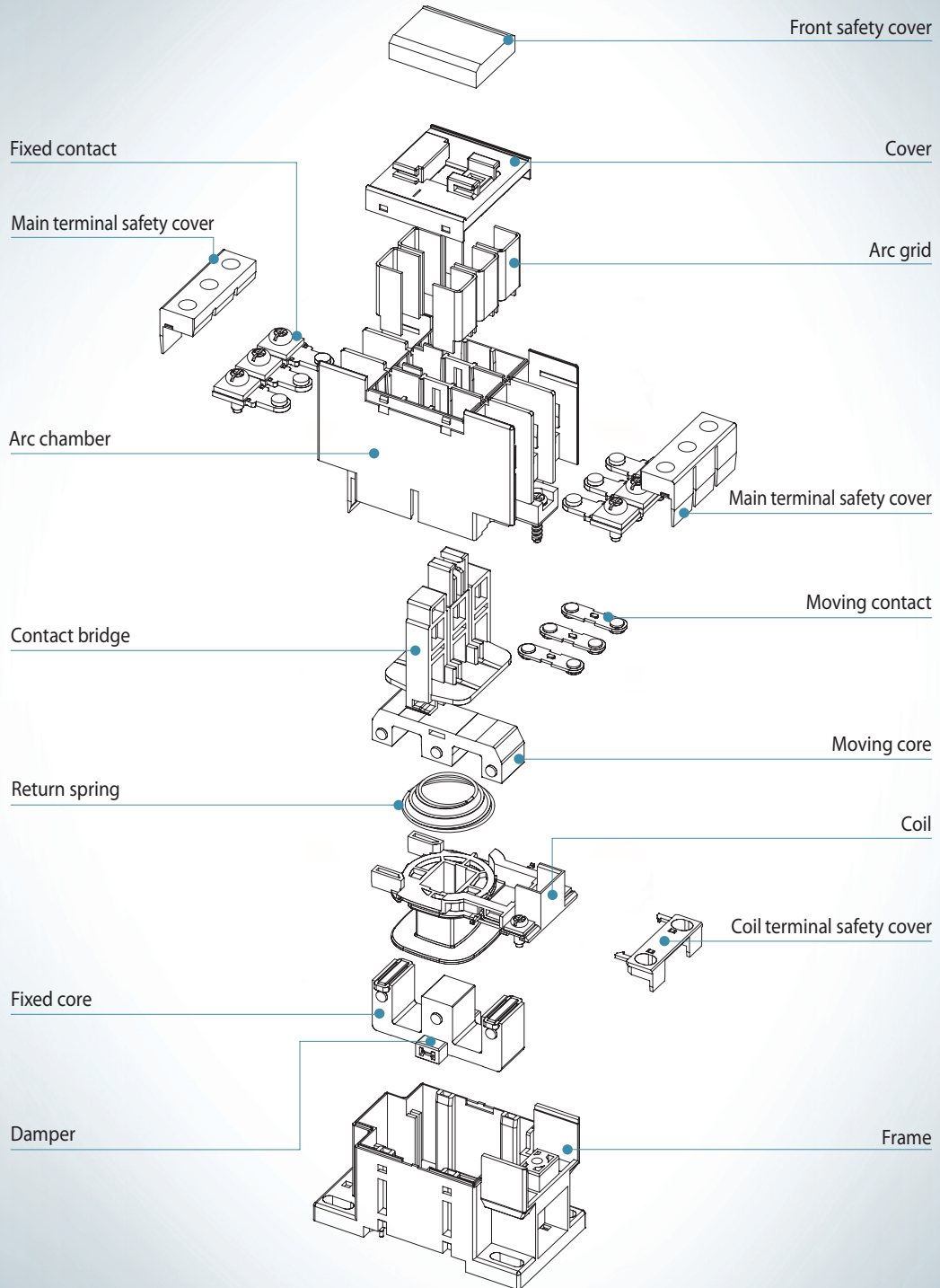

## Features

### Accessories

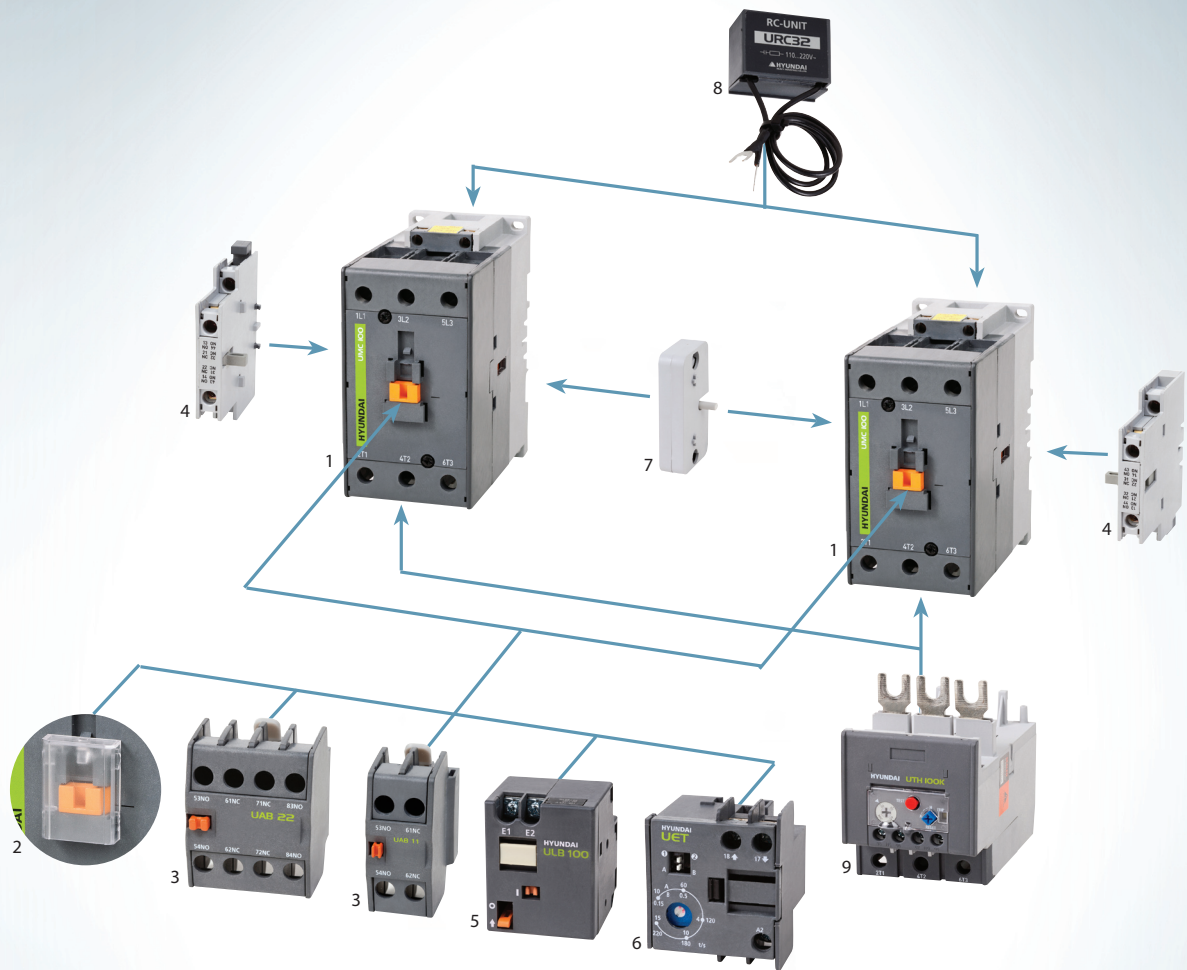

#### Accessories

- |  |   |
|--|---|
| 1. Contactor <b>UMC</b>                                | 2. Front safety cover                                 |
| 3. Auxiliary contact block (Front mounting) <b>UAB</b> | 4. Auxiliary contact block (Side mounting) <b>UAL</b> |
| 5. Mechanical latching block <b>ULB</b>                | 6. Electronic timer block <b>UET</b>                  |
| 7. Mechanical interlock unit <b>UTL</b>                | 8. Surge absorber <b>URC/UCD</b>                      |
| 9. Thermal overload relay <b>UTH</b>                   |   |

※ The applicable accessories of each contactor are not same as above. For exact application to each contactor, please refer to next pages.



# Contactors & Control Relay



UMC 100  
MAGNETIC CONTACTOR  
磁界開及閉機(電機)

IEC (EN) 60947-4-1

$I_n = 125A$   $U_n = 230V$   $U_{imp} = 80V$

$I_n$ (A)	$I_{th}$ (A)	$I_{th}$ (A)	$I_{th}$ (A)
20-25	25	20A	30
30-40	40	30A	40
50-60	60	50A	60
80-100	100	80A	100

規格 (A) 100A

電壓 (V)	電流 (A)
220V	100A
440V	100A

電機開閉電機開閉機

電機	電機
220-240	3PH
220-240	3PH
440-480	3PH

BREAK ALL LINES  
CONTINUOUS CURRENT : 125A  
MKG 1, 75°C CABLE ONLY  
MKG CONT. 1600-PP300  
TORQUE 60kgf-cm (6.0 N-m)

CE

MADE IN KOREA

HYUNDAI  
BEST PERFORMANCE

## Rating Overview

Model				UMC9	UMC12	UMC18	UMC25	UMC32	UMC40	UMC50	UMC65		
IEC60947	Rated insulation voltage [Ui]			V	AC750	AC750	AC750	AC750	AC750	AC750	AC750	AC750	
	Rated operation voltage [Ue]			V	AC690	AC690	AC690	AC690	AC690	AC690	AC690	AC690	
	Rated impulse withstand current [Uimp]			kV	6	6	8	8	8	8	8	8	
	Rated thermal current [Ith] (AC1)			A	25	25	40	45	55	60	70	100	
	Rated current	AC3 [Ie]	AC200-240V		kW/A	2.5/9	3.5/12	4.5/18	5.5/25	7.5/32	11/40	15/50	18.5/65
			AC380-440V			4/9	5.5/12	7.5/18	11/25	15/32	18.5/40	22/50	30/65
			AC500-550V			4/7	7.5/12	8.5/15	15/22	18.5/28	22/32	30/43	33/60
			AC660-690V			5.5/6	7.5/9	7.5/9	15/18	18.5/22	22/23	30/28	33/35
			AC1,000V			-	-	-	-	-	-	-	-
		Lifetime (440V)	Electrical	× 1,000 times	2,500	2,500	2,500	2,500	2,000	2,000	2,000	2,000	
					Mechanical	25,000	25,000	15,000	15,000	15,000	15,000	15,000	15,000
		AC4 [Ie]	AC200-240V			kW/A	1.5/8	2.2/11	3.7/16	3.7/18	4.5/22	5.5/25	7.5/35
			AC380-440V		2.2/6		4/9	4/11	5.5/13	7.5/17	11/24	15/32	22/47
			Electrical lifetime		× 1,000 times	30	30	30	30	30	30	30	30
	Operating frequency (per hour)	AC1	100% load		times	1,000	1,000	1,000	1,000	1,000	750	750	750
50% load			2,000	2,000		2,000	2,000	2,000	1,500(900) <sup>1)</sup>	1,500(900) <sup>1)</sup>	1,500(900) <sup>1)</sup>		
AC2		20% load		times	3,600	3,600	3,600	3,600	3,600	3,000(1200) <sup>1)</sup>	3,000(1200) <sup>1)</sup>	3,000(1200) <sup>1)</sup>	
		100% load			300	300	300	300	300	250	250	250	
AC4		50% load		times	600	600	600	600	600	500	500	500	
	100% load		300		300	300	300	300	250	250	250		
Making capacity		AC220V		A	110	130	180	250	320	400	500	650	
		AC440V			90	120	180	250	320	400	500	650	
Breaking capacity		AC220V		A	88	104	144	200	256	320	400	520	
		AC440V			72	96	144	200	256	320	400	520	
Continuous current at 40°C				A	21	21	30	40	50	60	70	80	
Rated current	1 phase	AC100-120V		HP/A	0.5/9.8	1/16	1.5/16	2/20	2/24	3/34	5/56	5/56	
		AC220-240V			1/8	2/12	3/17	3/17	5/28	7.5/40	10/50	10/50	
	3 phase	AC220-240V		HP/A	2/6.8	3/9.6	5/15.2	10/28	10/28	15/42	20/54	20/54	
		AC440-480V			5/7.6	7.5/11	10/14	20/27	25/34	30/40	40/52	40/52	
		AC550-600V			5/6.1	10/11	15/21	15/21	20/22	30/32	30/42	40/52	
NEMA size					00	00	0	0	1	1	2	2	
Mounting method				Screw & DIN-rail									
Application for hoist				● ● ● ● ● ● ● ●									
Contacts		Main		3NO		3NO		3NO		3NO			
		Auxiliary	AC		1NO or 1NC		-		-		-		
			DC		1NO or 1NC		-		-		2NO+1NC		
		AC/DC		-		-		-		-			
Dimensions		AC	Width ×	mm	44 × 75 × 80		45 × 83 × 94		55 × 106 × 111				
		DC	Height ×		44 × 75 × 112		45 × 83 × 127		55 × 106 × 111				
		AC/DC	Depth		-		-		-				
Weight		AC		kg	0.30		0.40		0.75				
		DC			0.55		0.70		0.75				
		AC/DC			-		-		-				

※ 1) The value in parentheses is for direct current (DC).

UMC75	UMC85	UMC100	UMC115	UMC130	UMC150	UMC185	UMC225	UMC265	UMC300	UMC400	UMC500	UMC630	UMC800
AC750	AC750	AC750	AC1,000	AC1,000	AC1,000	AC1,000	AC1,000	AC1,000	AC1,000	AC1,000	AC1,000	AC1,000	AC1,000
AC690	AC690	AC690	AC1,000	AC1,000	AC1,000	AC1,000	AC1,000	AC1,000	AC1,000	AC1,000	AC1,000	AC1,000	AC1,000
8	8	8	8	8	8	8	8	8	8	8	8	8	8
115	125	145	160	180	210	275	315	350	400	500	550	750	900
22/75	25/85	30/100	37/115	40/130	45/150	55/185	75/225	80/265	90/300	125/400	140/500	190/630	220/800
37/75	45/85	55/100	60/115	65/130	75/150	90/185	132/225	147/265	160/300	220/400	250/500	330/500	440/800
37/64	50/75	50/85	59/100	70/120	90/140	110/180	132/200	150/225	200/273	250/300	300/426	330/500	500/720
37/42	45/45	45/65	55/65	75/82	90/120	110/120	132/150	160/173	200/220	250/300	335/360	400/412	500/630
-	-	-	65/50	75/54	90/66	110/78	132/96	160/113	200/141	250/178	275/192	300/213	400/284
2,000	2,000	2,000	1,000	1,000	1,000	1,000	1,000	1,000	1,000	1,000	50	50	50
10,000	10,000	10,000	5,000	5,000	5,000	5,000	5,000	5,000	5,000	5,000	500	500	500
13/55	15/65	17/72	19/80	22/93	30/125	37/150	45/185	50/200	55/220	75/300	90/350	110/400	160/630
25/52	30/62	33/68	37/75	45/90	55/110	75/150	90/185	102/200	110/220	150/300	175/350	200/400	300/630
30	30	30	30	30	30	30	30	30	30	30	3	3	3
450	450	450	450	450	450	300	300	300	300	300	300	300	300
900	900	900	900	900	900	600	600	600	600	600	600	600	600
1,800(1,200) <sup>1)</sup>	1,800(1,200) <sup>1)</sup>	1,800(1,200) <sup>1)</sup>	1,800	1,800	1,800	1,200	1,200	1,200	1,200	1,200	1,200	1,200	1,200
200	200	200	200	200	200	200	200	200	150	150	150	150	150
400	400	400	400	400	400	400	400	400	300	300	300	300	300
750	850	1,000	1,150	1,300	1,500	1,850	2,250	2,650	3,000	4,000	5,000	6,300	8,000
750	850	1,000	1,150	1,300	1,500	1,850	2,250	2,650	3,000	4,000	5,000	6,300	8,000
600	680	800	920	1,040	1,200	1,480	1,800	2,120	2,400	3,200	4,000	5,040	6,400
600	680	800	920	1,040	1,200	1,480	1,800	2,120	2,400	3,200	4,000	5,040	6,400
90	105	125	160	180	210	230	260	330	350	450	550	750	900
-	-	-	-	-	-	-	-	-	-	-	-	-	-
-	-	-	-	-	-	-	-	-	-	-	-	-	-
25/68	30/80	30/80	40/104	40/104	50/130	60/154	75/192	100/248	100/248	150/360	150/360	250/480	300/720
60/77	60/77	60/77	75/96	75/96	100/124	125/156	150/180	200/240	250/302	300/361	300/361	500/477	600/708
50/52	50/52	75/77	100/99	100/99	125/125	150/144	200/192	250/242	250/242	300/289	350/336	500/382	600/578
2	3	3	3	3	4	4	4	4	5	5	5	6	7
Screw & DIN-rail			Screw										
●	●	●	-	-	-	-	-	-	-	-	-	-	-
3NO			3NO			3NO			3NO			3NO	
-			-			-			-			-	
2NO+1NC			-			-			-			-	
-			2NO+2NC			2NO+2NC			2NO+2NC			2NO+2NC	
70 × 140 × 128			-			-			-			-	
70 × 140 × 128			-			-			-			-	
-			103 × 155 × 146			138 × 204 × 174			163 × 243 × 203			276 × 314 × 253	
1.40			-			-			-			-	
1.40			-			-			-			-	
-			2.50			4.70			8.75			22	

※ 1) The value in parentheses is for direct current (DC).

# Specifications & Order Information



## Contactor | UMC 9-12A

Model			UMC9	UMC12		
IEC60947	Rated insulation voltage [Ui]		V	AC750	AC750	
	Rated operation voltage [Ue]		V	AC690	AC690	
	Rated impulse withstand current [Uimp]		kV	6	6	
	Rated thermal current [Ith] (AC1)		A	25	25	
	Rated current	AC3 [Ie]	AC200-240V	kW/A	2.5/9	3.5/12
			AC380-440V		4/9	5.5/12
			AC500-550V		4/7	7.5/12
			AC660-690V		5.5/6	7.5/9
			AC1,000V		-	-
		Lifetime	Electrical	× 1,000 times	2,500	2,500
		Mechanical		25,000	25,000	
	AC4 [Ie]	AC200-240V	kW/A	1.5/8	2.2/11	
		AC380-440V		2.2/6	4/9	
		Electrical lifetime		× 1,000 times	30	30
	Operating frequency (per hour)	AC1	100% load	times	1,000	1,000
AC2		50% load	2,000		2,000	
AC3		20% load	3,600		3,600	
AC4		100% load	times		300	300
	50% load	600		600		
Making capacity	AC220V	A	110	130		
	AC440V		90	120		
Breaking capacity	AC220V	A	88	104		
	AC440V		72	96		
Mounting method			Screw & DIN-rail			
Application for hoist			●	●		
Contacts	Main	3NO				
	Auxiliary	AC	1NO or 1NC			
		DC	1NO or 1NC			
Dimensions	AC	Width × Height × Depth	44 × 75 × 80			
	DC		44 × 75 × 112			
Weight	AC	kg	0.30			
	DC		0.55			

### ◆ Contact arrangement

Item	AC, DC	
Contactor only	<p>1NO</p>	<p>1NC</p>
	<p>3NO+2NC</p>	<p>2NO+3NC</p>

※ 1) For applicable auxiliary contact block, please refer to page 30, 31.

### ◆ Operation voltage

	(Unit: V)		
	AC, 50Hz	AC, 60Hz	DC
	24	24	24
	42	48	48
	48	100	60
	80	110	80
	100	120	100
	110	208	110
	120	220	125
	220	230	200
	230	240	220
	240	277	250
	380	380	
	400	440	
	415	460	
	440	480	

※ Non-specified voltage can be available on request. For technical information of coil, please refer to page 42, 43.

◆ Accessories

Contactor: UMC9-12

- 1. Front safety cover UMC100IC  
page 35
- 2. Auxiliary contact block (Front mounting) UAB  
page 30
- 3. Auxiliary contact block (Side mounting) UAL65  
page 30
- 4. Mechanical latching block ULB100  
page 33
- 5. Electronic timer block UET  
page 34
- 6. Mechanical interlock block UTL65  
page 32
- 7. Surge absorber URC/UCD  
page 35
- 8. Thermal overload relay UTH12  
page 50

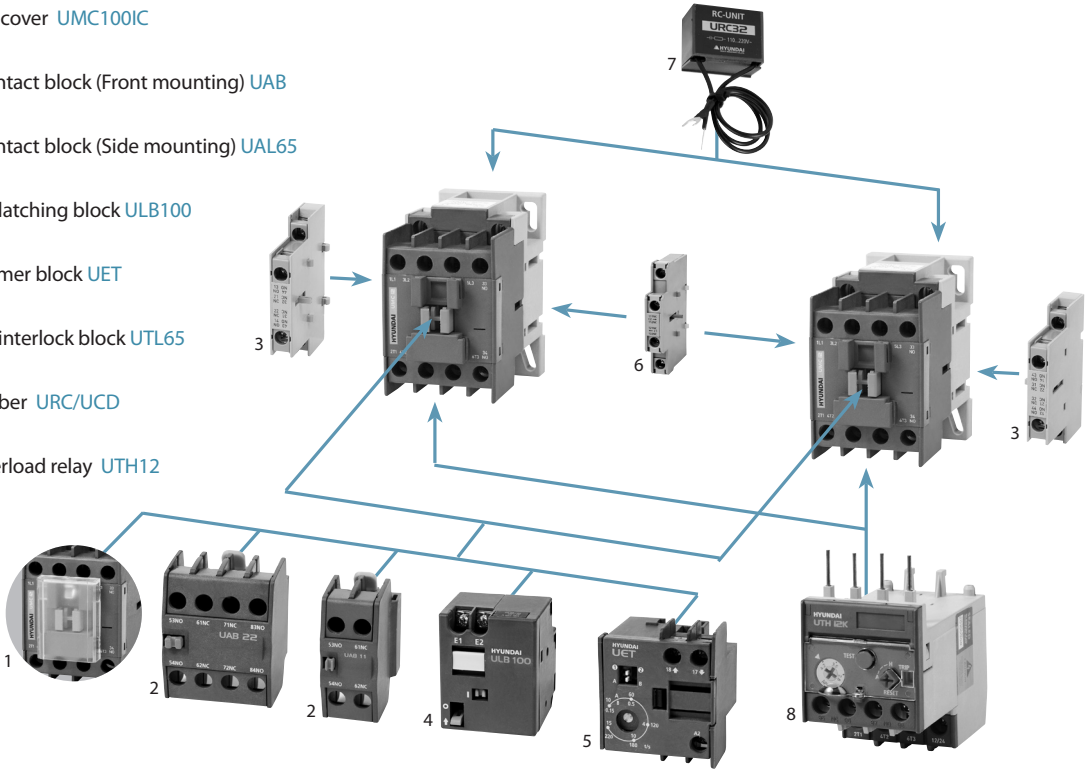

◆ Order information

UMC		12		
Code	Series	Code	Rated current	Power
UMC	UMC	9	9A	4kW
		12	12A	5.5kW

01		N		S	
Code	Auxiliary contact	Code	Application	Code	Terminal accessory
01	0NO+1NC	N	Standard	S	Safety cover
10	1NO+0NC	H	Hoist		

X220		
Code	Voltage (V)	Current, frequency
X	24-440	AC, 50Hz
A	24-480	AC, 60Hz
D	24-250	DC

◆ Standard order code and unit

Model	AC220V, 50Hz		AC220V, 60Hz		DC110V		Category	
	Code	Unit	Code	Unit	Code	Unit		
UMC9	UMC9 01NS X220	50	UMC9 01NS A220	50	UMC9 01NS D110	25	MC	CE
	UMC9 10NS X220	50	UMC9 10NS A220	50	UMC9 10NS D110	25		
UMC12	UMC12 01NS X220	50	UMC12 01NS A220	50	UMC12 01NS D110	25		
	UMC12 10NS X220	50	UMC12 10NS A220	50	UMC12 10NS D110	25		

# Specifications & Order Information



## Contactor | UMC 18-32A

Model			UMC18	UMC25	UMC32		
IEC60947	Rated insulation voltage [U <sub>i</sub> ]		V	AC750	AC750	AC750	
	Rated operation voltage [U <sub>e</sub> ]		V	AC690	AC690	AC690	
	Rated impulse withstand current [U <sub>imp</sub> ]		kV	8	8	8	
	Rated thermal current [I <sub>th</sub> ] (AC1)		A	40	45	55	
	Rated current	AC3 [I <sub>e</sub> ]	AC200-240V	kW/A	4.5/18	5.5/25	7.5/32
			AC380-440V		7.5/18	11/25	15/32
			AC500-550V		8.5/15	15/22	18.5/28
			AC660-690V		7.5/9	15/18	18.5/22
			AC1,000V		-	-	-
		Lifetime	Electrical	× 1,000 times	2,500	2,500	2,000
			Mechanical		15,000	15,000	15,000
		AC4 [I <sub>e</sub> ]	AC200-240V	kW/A	3.7/16	3.7/18	4.5/22
	AC380-440V		4/11		5.5/13	7.5/17	
	Electrical lifetime		× 1,000 times		30	30	30
	Operating frequency (per hour)	AC1	100% load	times	1,000	1,000	1,000
AC2		50% load	2,000		2,000	2,000	
AC3		20% load	3,600		3,600	3,600	
AC4		100% load	times		300	300	300
	50% load	600		600	600		
Making capacity	AC220V	A	180	250	320		
	AC440V		180	250	320		
Breaking capacity	AC220V	A	144	200	256		
	AC440V		144	200	256		
Mounting method			Screw & DIN-rail				
Application for hoist			●	●	●		
Contacts	Main	3NO					
	Auxiliary	AC	-				
		DC	-				
Dimensions	AC	Width × Height × Depth	mm	45 × 83 × 94			
	DC			45 × 83 × 127			
Weight	AC		kg	0.40			
	DC			0.70			

### ◆ Contact arrangement

Item	AC, DC
Contactor only	
Contactor with side mounting auxiliary contact block <sup>1)</sup> (max.)	<p style="text-align: center;">2NO+2NC</p>

※ 1) For applicable auxiliary contact block, please refer to page 30, 31.

### ◆ Operation voltage

	(Unit: V)		
	AC, 50Hz	AC, 60Hz	DC
	24	24	24
	42	48	48
	48	100	60
	80	110	80
	100	120	100
	110	208	110
	120	220	125
	220	230	200
	230	240	220
	240	277	250
	380	380	
	400	440	
	415	460	
	440	480	

※ Non-specified voltage can be available on request. For technical information of coil, please refer to page 42, 43.

◆ Accessories

Contactor: UMC18-32

1. Front safety cover UMC100IC  
page 35
2. Auxiliary contact block (Front mounting) UAB  
page 30
3. Auxiliary contact block (Side mounting) UAL65  
page 30
4. Mechanical latching block ULB100  
page 33
5. Electronic timer block UET  
page 34
6. Mechanical interlock block UTL65  
page 32
7. Surge absorber URC/UCD  
page 35
8. Thermal overload relay UTH32  
page 50

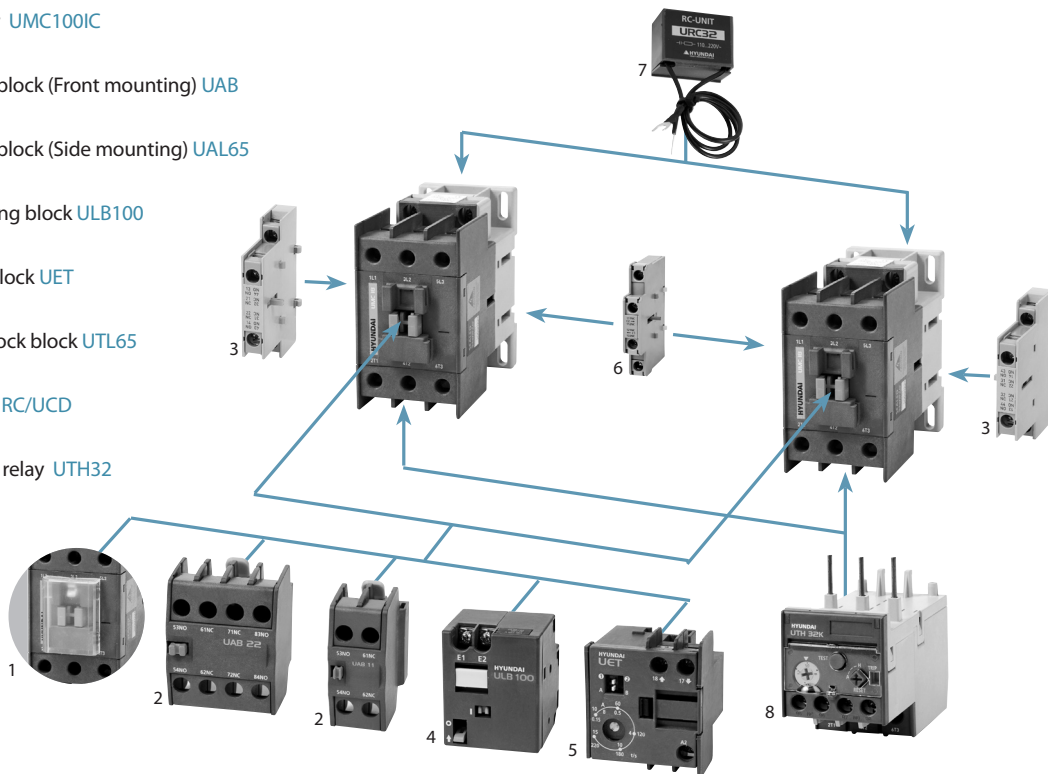

◆ Order information

UMC		32		
Code	Series	Code	Rated current	Power
UMC	UMC	18	18A	7.5kW
		25	25A	11kW
		32	32A	15kW

00		N		S	
Code	Auxiliary contact	Code	Application	Code	Terminal accessory
00	0NO+0NC	N	Standard	S	Safety cover
		H	Hoist		

X220		
Code	Voltage (V)	Current, frequency
X	24-440	AC, 50Hz
A	24-480	AC, 60Hz
D	24-250	DC

◆ Standard order code and unit

Model	AC220V, 50Hz		AC220V, 60Hz		DC110V		Category	
	Code	Unit	Code	Unit	Code	Unit		
UMC18	UMC18 00NS X220	40	UMC18 00NS A220	40	UMC18 00NS D110	20	MC	CE
UMC25	UMC25 00NS X220	40	UMC25 00NS A220	40	UMC25 00NS D110	20		
UMC32	UMC32 00NS X220	40	UMC32 00NS A220	40	UMC32 00NS D110	20		

# Specifications & Order Information



## Contactor | UMC 40-65A

Model			UMC40	UMC50	UMC65		
IEC60947	Rated insulation voltage [Ui]		V	AC750	AC750	AC750	
	Rated operation voltage [Ue]		V	AC690	AC690	AC690	
	Rated impulse withstand current [Uimp]		kV	8	8	8	
	Rated thermal current [Ith] (AC1)		A	60	70	100	
	Rated current	AC3 [Ie]	AC200-240V	kW/A	11/40	15/50	18.5/65
			AC380-440V		18.5/40	22/50	30/65
			AC500-550V		22/32	30/43	33/60
			AC660-690V		22/23	30/28	33/35
			AC1,000V		-	-	-
		Lifetime	Electrical	× 1,000 times	2,000	2,000	2,000
			Mechanical	15,000	15,000	15,000	
	AC4 [Ie]	AC200-240V	kW/A	5.5/25	7.5/35	11/50	
		AC380-440V		11/24	15/32	22/47	
		Electrical lifetime		× 1,000 times	30	30	30
	Operating frequency (per hour)	AC1	100% load	times	750	750	750
AC2		50% load	1,500(900) <sup>1)</sup>		1,500(900) <sup>1)</sup>	1,500(900) <sup>1)</sup>	
AC3		20% load	3,000(1,200) <sup>1)</sup>		3,000(1,200) <sup>1)</sup>	3,000(1,200) <sup>1)</sup>	
AC4		100% load	times		250	250	250
	50% load	500		500	500		
Making capacity	AC220V	A	400	500	650		
	AC440V		400	500	650		
Breaking capacity	AC220V	A	320	400	520		
	AC440V		320	400	520		
Mounting method			Screw & DIN-rail				
Application for hoist			●	●	●		
Contacts	Main	3NO					
	Auxiliary	AC	-				
		DC	2NO+1NC				
Dimensions	AC	Width × Height × Depth	mm	55 × 106 × 111			
	DC			55 × 106 × 111			
Weight	AC		kg	0.75			
	DC			0.75			

※ 1) The value in parentheses is for direct current (DC).

### ◆ Contact arrangement

Item	AC	DC
Contactor only		
Contactor with side mounting auxiliary contact block <sup>1)</sup> (max.)	<p>2NO+2NC</p>	<p>2NO+1NC</p>

※ 1) For applicable auxiliary contact block, please refer to page 30, 31.

### ◆ Operation voltage

(Unit: V)		
AC, 50Hz	AC, 60Hz	DC
24	24	24
42	48	48
48	100	60
80	110	80
100	120	100
110	208	110
120	220	125
220	230	200
230	240	220
240	277	250
380	380	
400	440	
415	460	
440	480	

※ Non-specified voltage can be available on request. For technical information of coil, please refer to page 42, 43.



◆ Accessories

Contactor: UMC40-65

- 1. Front safety cover UMC100IC  
page 35
- 2. Auxiliary contact block (Front mounting) UAB  
page 30
- 3. Auxiliary contact block (Side mounting) UAL65  
page 30
- 4. Mechanical latching block ULB100  
page 33
- 5. Electronic timer block UET  
page 34
- 6. Mechanical interlock block UTL65  
page 32
- 7. Surge absorber URC/UCD  
page 35
- 8. Thermal overload relay UTH65  
page 50

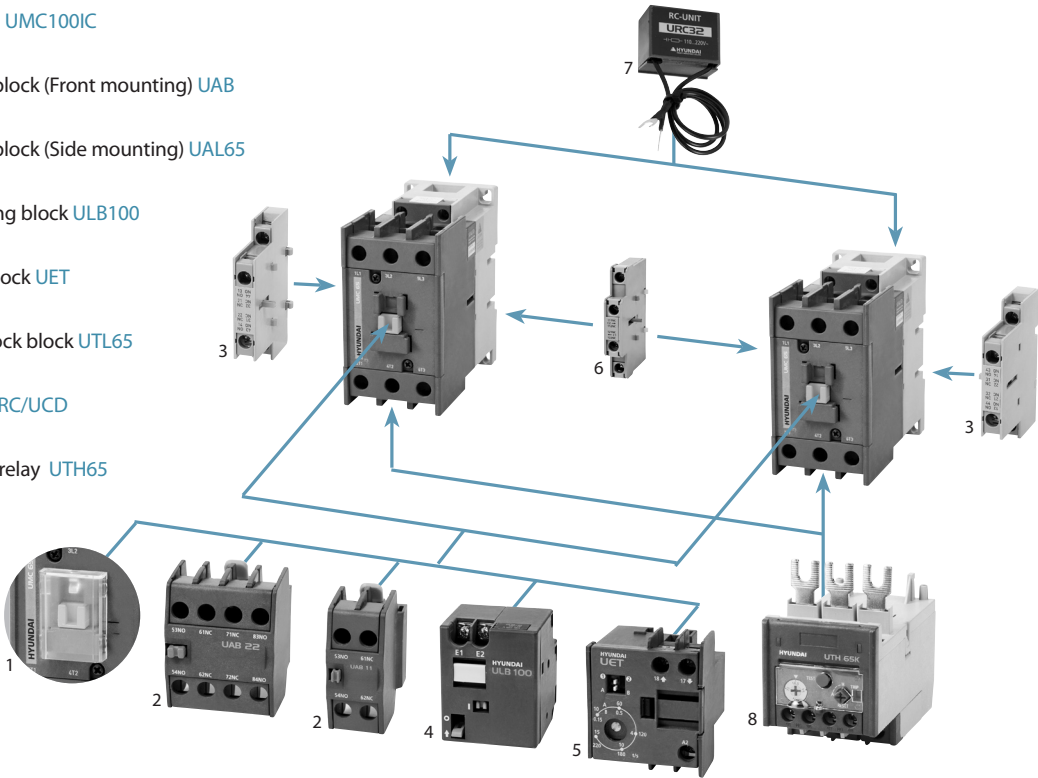

◆ Order information

UMC		65		
Code	Series	Code	Rated current	Power
UMC	UMC		AC3, AC440V	
		40	40A	18.5kW
		50	50A	22kW
		65	65A	30kW

00		N		S	
Code	Auxiliary contact	Code	Application	Code	Terminal accessory
00 <sup>1)</sup>	0NO+0NC	N	Standard	S	Safety cover
21 <sup>2)</sup>	2NO+1NC	H	Hoist		Cage lug

※ 1) for AC  
2) for DC

X220		
Code	Voltage (V)	Current, frequency
X	24-440	AC, 50Hz
A	24-480	AC, 60Hz
D	24-250	DC

◆ Standard order code and unit

Model	AC220V, 50Hz		AC220V, 60Hz		DC110V		Category	
	Code	Unit	Code	Unit	Code	Unit		
UMC40	UMC40 00NS X220	16	UMC40 00NS A220	16	UMC40 21NS D110	16	MC	CE
UMC50	UMC50 00NS X220	16	UMC50 00NS A220	16	UMC50 21NS D110	16		
UMC65	UMC65 00NS X220	16	UMC65 00NS A220	16	UMC65 21NS D110	16		

# Specifications & Order Information



## Contactor | UMC 75-100A

Model		UMC75	UMC85	UMC100	
IEC60947	Rated insulation voltage [Ui]	V	AC750	AC750	
	Rated operation voltage [Ue]	V	AC690	AC690	
	Rated impulse withstand current [Uimp]	kV	8	8	
	Rated thermal current [Ith] (AC1)	A	115	125	
	Rated current	AC3 [Ie]	AC200-240V	22/75	25/85
			AC380-440V	37/75	45/85
			AC500-550V	37/64	50/75
			AC660-690V	37/42	45/45
			AC1,000V	-	-
		Lifetime	Electrical	× 1,000	2,000
		Mechanical	times	10,000	10,000
	AC4 [Ie]	AC200-240V	kW/A	13/55	15/65
		AC380-440V		25/52	30/62
		Electrical lifetime	× 1,000 times	30	30
	Operating frequency (per hour)	AC1	100% load	times	450
AC2		50% load		900	
AC3		20% load		1,800(1,200) <sup>1)</sup>	
AC4		100% load	times	200	
		50% load		400	
Making capacity	AC220V	A	750	850	
	AC440V		750	850	
Breaking capacity	AC220V	A	600	680	
	AC440V		600	680	
Mounting method		Screw & DIN-rail			
Application for hoist		●	●	●	
Contacts	Main	3NO			
	Auxiliary	AC	-		
		DC	2NO+1NC		
Dimensions	AC	Width × Height × Depth	mm		
	DC		70 × 140 × 128		
Weight	AC	kg	1.40		
	DC		1.40		

※ 1) The value in parentheses is for direct current (DC).

### ◆ Contact arrangement

Item	AC	DC
Contactor only		
Contactor with side mounting auxiliary contact block <sup>1)</sup> (max.)	<p>2NO+2NC</p>	<p>2NO+1NC</p>

※ 1) For applicable auxiliary contact block, please refer to page 30, 31.

### ◆ Operation voltage

(Unit: V)		
AC, 50Hz	AC, 60Hz	DC
24	24	24
42	48	48
48	100	60
80	110	80
100	120	100
110	208	110
120	220	125
220	230	200
230	240	220
240	277	250
380	380	
400	440	
415	460	
440	480	

※ Non-specified voltage can be available on request. For technical information of coil, please refer to page 42, 43.

◆ Accessories

Contactor: UMC75-100

- 1. Front safety cover UMC100IC  
page 35
- 2. Auxiliary contact block (Front mounting) UAB  
page 30
- 3. Auxiliary contact block (Side mounting) UAL100  
page 30
- 4. Mechanical latching block ULB100  
page 33
- 5. Electronic timer block UET  
page 34
- 6. Mechanical interlock block UTL100  
page 32
- 7. Surge absorber URC/UCD  
page 35
- 8. Thermal overload relay UTH100  
page 50

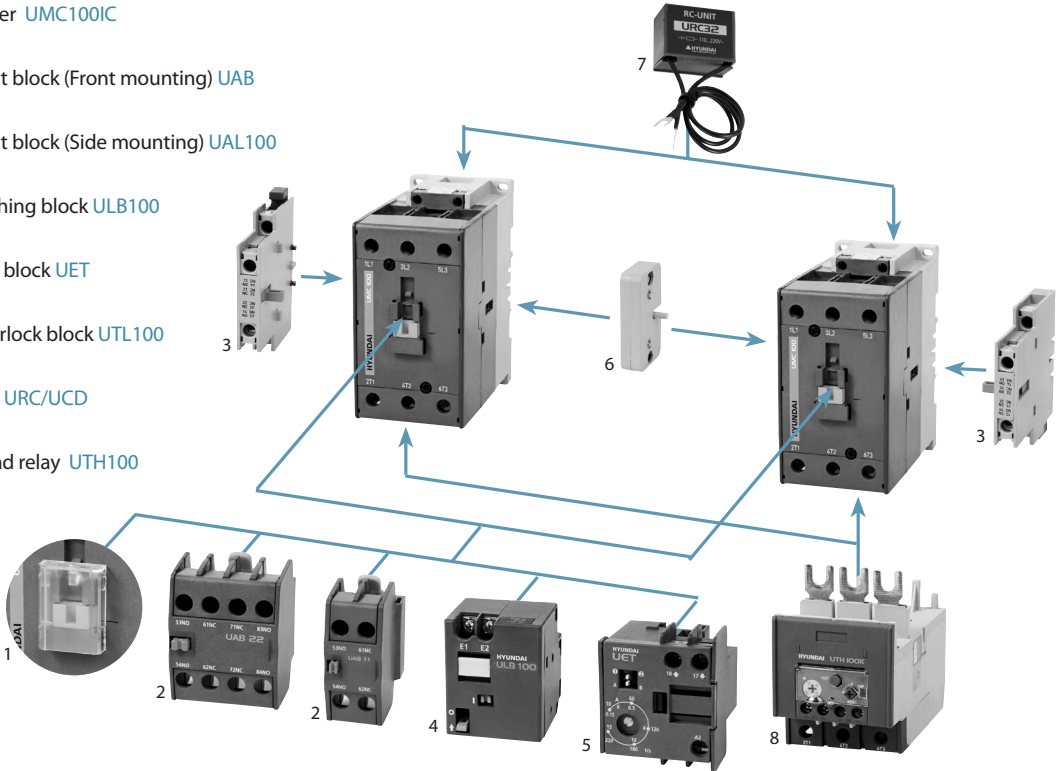

◆ Order information

UMC		100		
Code	Series	Code	Rated current	Power
UMC	UMC	75	75A	37kW
		85	85A	45kW
		100	100A	55kW

00		N		S	
Code	Auxiliary contact	Code	Application	Code	Terminal accessory
00 <sup>1)</sup>	0NO+0NC	N	Standard	S	Safety cover
21 <sup>2)</sup>	2NO+1NC	H	Hoist		Cage lug

※ 1) for AC  
2) for DC

X220		
Code	Voltage (V)	Current, frequency
X	24-440	AC, 50Hz
A	24-480	AC, 60Hz
D	24-250	DC

◆ Standard order code and unit

Model	AC220V, 50Hz		AC220V, 60Hz		DC110V		Category	
	Code	Unit	Code	Unit	Code	Unit		
UMC75	UMC75 00NS X220	9	UMC75 00NS A220	9	UMC75 21NS D110	6	MC	CE
UMC85	UMC85 00NS X220	9	UMC85 00NS A220	9	UMC85 21NS D110	6		
UMC100	UMC100 00NS X220	9	UMC100 00NS A220	9	UMC100 21NS D110	6		

# Specifications & Order Information



## Contactor | UMC 115-150A

Model				UMC115	UMC130	UMC150	
IEC60947	Rated insulation voltage [Ui]		V	AC1,000	AC1,000	AC1,000	
	Rated operation voltage [Ue]		V	AC1,000	AC1,000	AC1,000	
	Rated impulse withstand current [Uimp]		kV	8	8	8	
	Rated thermal current [Ith] (AC1)		A	160	180	210	
	Rated current	AC3 [Ie]	AC200-240V	kW/A	37/115	40/130	45/150
			AC380-440V		60/115	65/130	75/150
			AC500-550V		59/100	70/120	90/140
			AC660-690V		55/65	75/82	90/120
			AC1,000V		65/50	75/54	90/66
		Lifetime	Electrical	× 1,000 times	1,000	1,000	1,000
		Mechanical	5,000		5,000	5,000	
	AC4 [Ie]	AC200-240V	kW/A	19/80	22/93	30/125	
		AC380-440V		37/75	45/90	55/110	
		Electrical lifetime		× 1,000 times	30	30	30
	Operating frequency (per hour)	AC1	100% load	times	450	450	450
50% load			900		900	900	
20% load			1,800		1,800	1,800	
AC4		100% load	times	200	200	200	
		50% load		400	400	400	
Making capacity	AC220V	A	1,150	1,300	1,500		
	AC440V		1,150	1,300	1,500		
Breaking capacity	AC220V	A	920	1,040	1,200		
	AC440V		920	1,040	1,200		
Mounting method				Screw			
Contacts	Main			3NO			
	Auxiliary	AC/DC		2NO+2NC			
Dimensions	AC/DC	Width × Height × Depth	mm	103 × 155 × 146			
Weight	AC/DC		kg	2.50			

### ◆ Contact arrangement

Item	AC/DC
Contactor only	<p>2NO+2NC</p>
Contactor with side mounting auxiliary contact block <sup>1)</sup> (max.)	<p>4NO+4NC</p>

※ 1) For applicable auxiliary contact block, please refer to page 30, 31.

### ◆ Operation voltage

(Unit: V)

	AC/DC	
	Voltage band	
24	AC: 24-26	DC: 24
48	AC: 44-52	DC: 48
220	AC: 100-240	DC: 110-220
440	AC: 380-450	

※ Non-specified voltage can be available on request. For technical information of coil, please refer to page 42, 43.

◆ Accessories

Contactor: UMC115-150

- 1. Front safety cover UMC150IC  
page 35
- 2. Auxiliary contact block  
(Side mounting) UAL400  
page 30
- 3. Mechanical interlock block UTL265  
page 32
- 4. Thermal overload relay UTH150  
page 52

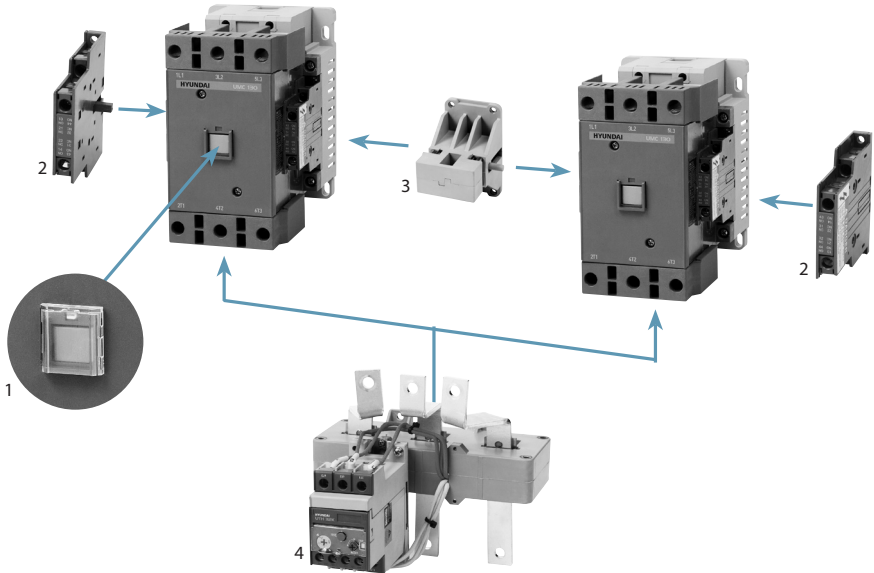

◆ Order information

UMC		150		
Code	Series	Code	Rated current	Power
			AC3, AC440V	
UMC	UMC	115	115A	60kW
		130	130A	65kW
		150	150A	75kW

22		N		S	
Code	Auxiliary contact	Code	Application	Code	Terminal accessory
22	2NO+2NC	N	Standard	S	Safety cover

F220		
Code	Voltage (V)	Current
	F	
48		
220		
440		

◆ Standard order code and unit

Model	AC/DC220V		Category	
	Code	Unit		
UMC115	UMC115 22NS F220	6	MC	CE
UMC130	UMC130 22NS F220	6		
UMC150	UMC150 22NS F220	6		

# Specifications & Order Information



## Contactor | UMC 185-265A

Model				UMC185	UMC225	UMC265	
IEC60947	Rated insulation voltage [U <sub>i</sub> ]		V	AC1,000	AC1,000	AC1,000	
	Rated operation voltage [U <sub>e</sub> ]		V	AC1,000	AC1,000	AC1,000	
	Rated impulse withstand current [U <sub>imp</sub> ]		kV	8	8	8	
	Rated thermal current [I <sub>th</sub> ] (AC1)		A	275	315	350	
	Rated current	AC3 [I <sub>e</sub> ]	AC200-240V	kW/A	55/185	75/225	80/265
			AC380-440V		90/185	132/225	147/265
			AC500-550V		110/180	132/200	150/225
			AC660-690V		110/120	132/150	160/173
			AC1,000V		110/78	132/96	160/113
		Lifetime	Electrical	× 1,000 times	1,000	1,000	1,000
		Mechanical		5,000	5,000	5,000	
	AC4 [I <sub>e</sub> ]	AC200-240V	kW/A	37/150	45/185	50/200	
		AC380-440V		75/150	90/185	102/200	
		Electrical lifetime		× 1,000 times	30	30	30
	Operating frequency (per hour)	AC1	100% load	times	300	300	300
AC2		50% load	600		600	600	
AC3		20% load	1,200		1,200	1,200	
AC4		100% load	times	200	200	200	
		50% load		400	400	400	
Making capacity	AC220V	A	1,850	2,250	2,650		
	AC440V		1,850	2,250	2,650		
Breaking capacity	AC220V	A	1,480	1,800	2,120		
	AC440V		1,480	1,800	2,120		
Mounting method				Screw			
Contacts	Main			3NO			
	Auxiliary	AC/DC		2NO+2NC			
Dimensions	AC/DC	Width × Height × Depth	mm	138 × 204 × 174			
Weight	AC/DC		kg	4.70			

### ◆ Contact arrangement

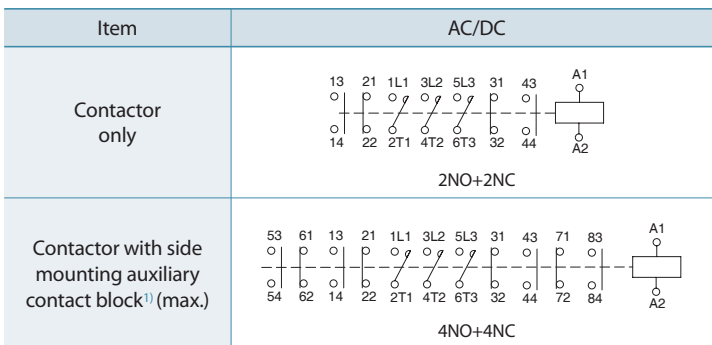

※ 1) For applicable auxiliary contact block, please refer to page 30, 31.

### ◆ Operation voltage

(Unit: V)

	AC/DC	
	Voltage band	
24	AC: 24-26	DC: 24
48	AC: 44-52	DC: 48
220	AC: 100-240	DC: 110-220
440	AC: 380-450	

※ Non-specified voltage can be available on request. For technical information of coil, please refer to page 42, 43.

◆ Accessories

Contactor: UMC185-265

- 1. Front safety cover UMC2651C  
page 35
- 2. Auxiliary contact block  
(Side mounting) UAL400  
page 30
- 3. Mechanical interlock block UTL265  
page 32
- 4. Thermal overload relay UTH265  
page 52

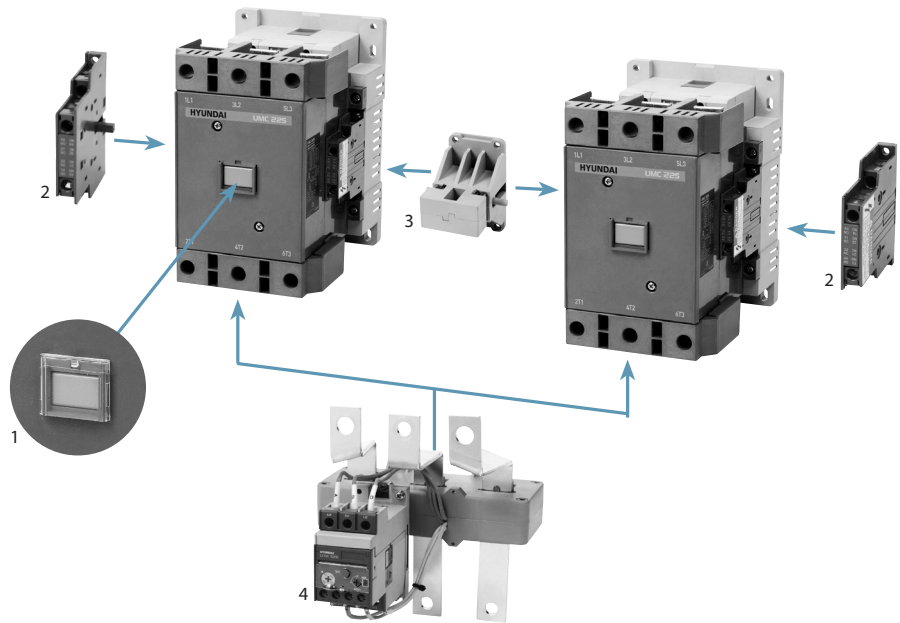

◆ Order information

UMC		265		
Code	Series	Code	Rated current	Power
AC3, AC440V				
UMC	UMC	185	185A	90kW
		225	225A	132kW
		265	265A	147kW

22		N		S	
Code	Auxiliary contact	Code	Application	Code	Terminal accessory
22	2NO+2NC	N	Standard	S	Safety cover

F220		
Code	Voltage (V)	Current
F	24	AC/DC
	48	
	220	
	440	

◆ Standard order code and unit

Model	AC/DC220V		Category	
	Code	Unit		
UMC185	UMC185 22NS F220	3	MC	CE
UMC225	UMC225 22NS F220	3		
UMC265	UMC265 22NS F220	3		

# Specifications & Order Information



## Contactor | UMC 300-500A

Model				UMC300	UMC400	UMC500	
IEC60947	Rated insulation voltage [Ui]		V	AC1,000	AC1,000	AC1,000	
	Rated operation voltage [Ue]		V	AC1,000	AC1,000	AC1,000	
	Rated impulse withstand current [Uimp]		kV	8	8	8	
	Rated thermal current [Ith] (AC1)		A	400	500	550	
	Rated current	AC3 [Ie]	AC200-240V	kW/A	90/300	125/400	140/500
			AC380-440V		160/300	220/400	250/500
			AC500-550V		200/273	250/300	300/426
			AC660-690V		200/220	250/300	335/360
			AC1,000V		200/141	250/178	275/192
		Lifetime	Electrical	× 1,000 times	1,000	1,000	500
		Mechanical		5,000	5,000	5,000	
	AC4 [Ie]	AC200-240V	kW/A	55/220	75/300	90/350	
		AC380-440V		110/220	150/300	175/350	
		Electrical lifetime		× 1,000 times	30	30	30
	Operating frequency (per hour)	AC1	100% load	times	300	300	300
		AC2	50% load		600	600	600
		AC3	20% load		1,200	1,200	1,200
		AC4	100% load	times	150	150	150
50% load			300		300	300	
Making capacity	AC220V	A	3,000	4,000	5,000		
	AC440V		3,000	4,000	5,000		
Breaking capacity	AC220V	A	2,400	3,200	4,000		
	AC440V		2,400	3,200	4,000		
Mounting method				Screw			
Contacts	Main			3NO			
	Auxiliary AC/DC			2NO+2NC			
Dimensions	AC/DC	Width × Height × Depth	mm				
Weight	AC/DC	kg	8.75				

### ◆ Contact arrangement

Item	AC/DC
Contactor only	<p style="text-align: center;">2NO+2NC</p>
Contactor with side mounting auxiliary contact block <sup>1)</sup> (max.)	<p style="text-align: center;">4NO+4NC</p>

※ 1) For applicable auxiliary contact block, please refer to page 30, 31.

### ◆ Operation voltage

(Unit: V)

	AC/DC	
	Voltage band	
220	AC: 100-240	DC: 110-220
440	AC: 380-450	

※ Non-specified voltage can be available on request. For technical information of coil, please refer to page 42, 43.



◆ Accessories

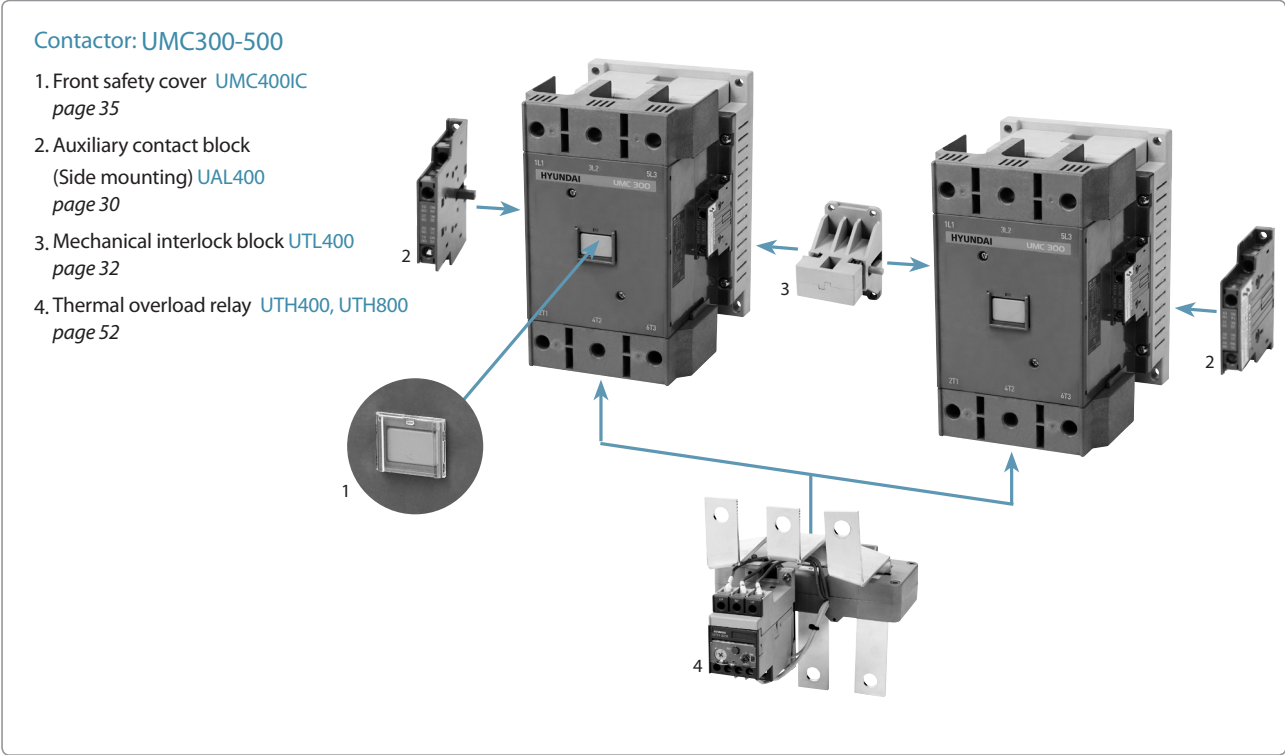

◆ Order information

UMC		500		
Code	Series	Code	Rated current	Power
			AC3, AC440V	
UMC	UMC	300	300A	160kW
		400	400A	220kW
		500	500A	250kW

22		N		S	
Code	Auxiliary contact	Code	Application	Code	Terminal accessory
22	2NO+2NC	N	Standard	S	Safety cover

F220		
Code	Voltage (V)	Current
F	220	AC/DC
	440	

◆ Standard order code and unit

Model	AC/DC220V		Category	
	Code	Unit		
UMC300	UMC300 22NS F220	2	MC	CE
UMC400	UMC400 22NS F220	2		
UMC500	UMC500 22NS F220	2		

# Specifications & Order Information



## Contactor | UMC 630-800A

Model				UMC630	UMC800	
IEC60947	Rated insulation voltage [Ui]		V	AC1,000	AC1,000	
	Rated operation voltage [Ue]		V	AC1,000	AC1,000	
	Rated impulse withstand current [Uimp]		kV	8	8	
	Rated thermal current [Ith] (AC1)		A	750	900	
	Rated current	AC3 [Ie]	AC200-240V	kW/A	190/600	220/800
			AC380-440V		330/630	440/800
			AC500-550V		330/500	500/720
			AC660-690V		400/412	500/630
			AC1,000V		300/213	400/284
		Lifetime	Electrical	× 1,000 times	500	500
			Mechanical	5,000	5,000	
	AC4 [Ie]	AC200-240V	kW/A	110/400	160/630	
		AC380-440V		200/400	300/630	
		Electrical lifetime		× 1,000 times	30	30
	Operating frequency (per hour)	AC1	100% load	times	300	300
AC2		50% load	600		600	
AC3		20% load	1,200		1,200	
AC4		100% load	times	150	150	
	50% load	300		300		
Making capacity	AC220V		A	6,300	8,000	
	AC440V			6,300	8,000	
Breaking capacity	AC220V		A	5,040	6,400	
	AC440V			5,040	6,400	
Mounting method				Screw		
Contacts	Main			3NO		
	Auxiliary	AC/DC		2NO+2NC		
Dimensions	AC/DC	Width × Height × Depth	mm	276 × 314 × 253		
Weight	AC/DC		kg	22		

### ◆ Contact arrangement

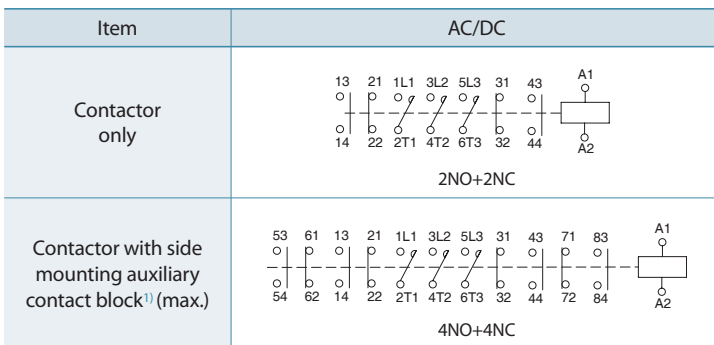

※ 1) For applicable auxiliary contact block, please refer to page 30, 31.

### ◆ Operation voltage

(Unit: V)

	AC/DC	
	Voltage band	
220	AC: 100-240	DC: 110-220
440	AC: 380-450	

※ Non-specified voltage can be available on request. For technical information of coil, please refer to page 42, 43.

◆ Accessories

Contactor: UMC630-800

- 1. Front safety cover UMC800IC  
page 35
- 2. Auxiliary contact block  
(Side mounting) UAL400  
page 30
- 3. Mechanical interlock block UTL400  
page 32
- 4. Thermal overload relay UTH800  
page 52

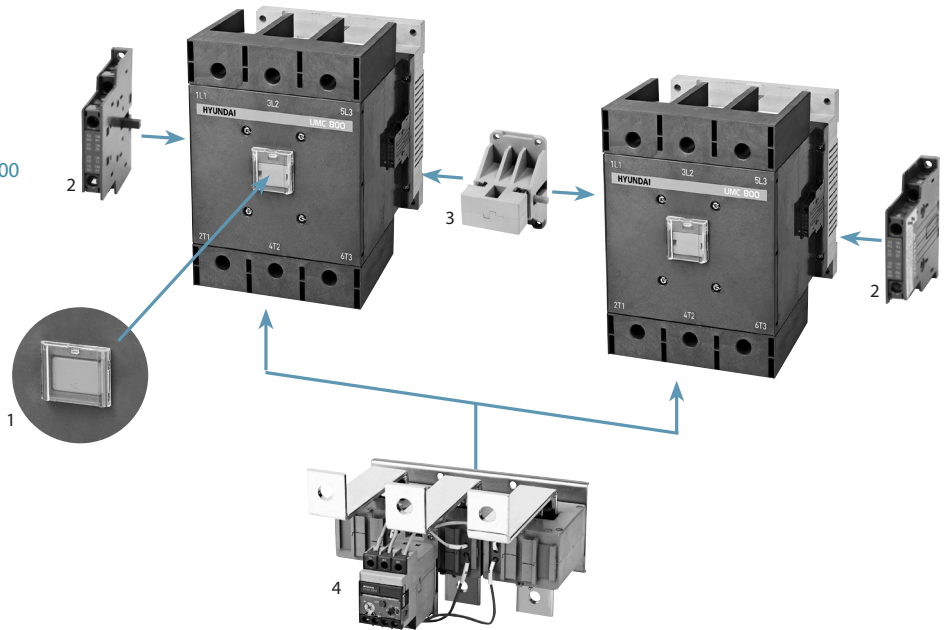

◆ Order information

UMC		800		
Code	Series	Code	Rated current	Power
			AC3, AC440V	
UMC	UMC	630	630A	330kW
		800	800A	400kW

22		N		S	
Code	Auxiliary contact	Code	Application	Code	Terminal accessory
22	2NO+2NC	N	Standard	S	Safety cover

F220		
Code	Voltage (V)	Current
F	220	AC/DC
	440	

◆ Standard order code and unit

Model	AC/DC220V		Category	
	Code	Unit		
UMC630	UMC630 22NS F220	1	MC	CE
UMC800	UMC800 22NS F220	1		

# Specifications & Order Information

## Control relay | UMX, UMT

- ◆ HYUNDAI control relay is the best solution where quick response time is required such as in control circuit and factory automation.
- ◆ UMX is for AC operation, and UMT is for DC operation.
- ◆ Both UMX and UMT have five contact arrangements; 4NC, 1NO+3NC, 2NO+2NC, 3NO+1NC, 4NO.
- ◆ The protection degree is IP20.
- ◆ Accessories can be attached by one-touch method.
  - Auxiliary contact block • Electronic timer • Latching block • Surge absorber
- ◆ Maximum NC contact  
4NC is the maximum contact combination of control relay including auxiliary contact block.  
Front mounting auxiliary contact block (UAB) can be attached on control relay; however, side mounting auxiliary contact block (UAL) is not applicable.
- ◆ Applicable standard  
IEC60947-5-1, VDE0660, CENELEC-EN50011

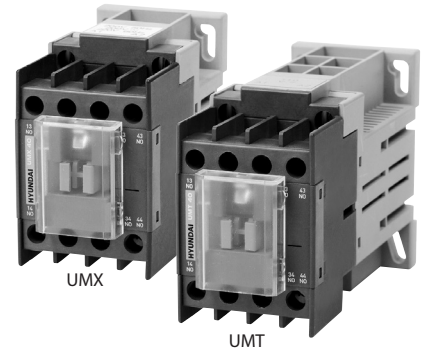

### Ratings & characteristics

Model		UMX		UMT		
		AC operation		DC operation		
Rated insulation voltage [Ui]	IEC60947 VDE0660	V		AC750 AC1,000		
Rated thermal current [Ith] (AC1)		A		20		
Rated current [Ie]	AC15	AC220V	A	10		
				AC380V	4	
				AC440V	3.5	
				AC500V	3	
				AC690V	2	
	DC12 (Resistive load)	DC24V	A	5		
				DC48V	3	
				DC110V	2.5	
				DC220V	1	
	DC13 (Coil load)	DC24V	A	3		
				DC48V	2	
				DC110V	1	
	UL/CSA	DC220V	A	0.6		
				AC120V	6	
				AC240V	3	
	DC125V		1.1			
Mechanical lifetime	× 1,000	times	15,000			
Cable size		mm <sup>2</sup>	2 × 0.75-2.5			
Operating frequency (per hour)		times	3,000			
Short circuit protection	Plug-fuse (Fast/Slow)	A	35/25			
	MCB (C curve)		16			
	HRC fuse (DIN/BS88)		25			
Mounting method			Screw & DIN-rail			
Auxiliary contacts			0NO+4NC			
			1NO+3NC			
			2NO+2NC			
			3NO+1NC			
			4NO+0NC			
Coil power consumption	Inrush		80VA/64W(60Hz)	7W		
	Normal		80VA/2.5W(60Hz)	7W		
Dimensions	Width × Height × Depth	mm	44 × 75 × 80	44 × 75 × 112		
Weight		kg	0.3	0.55		

### Contact arrangement

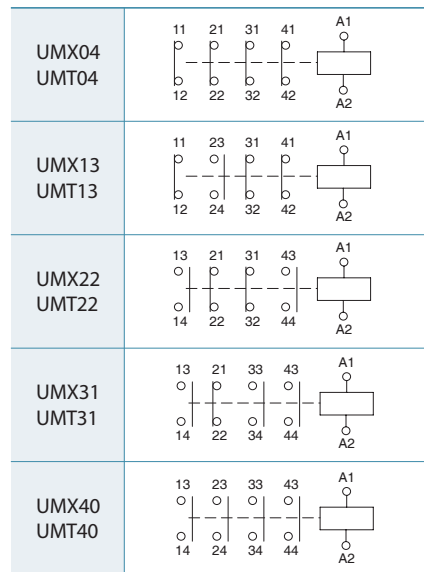

### Operation voltage

(Unit: V)		
AC, 50Hz	AC, 60Hz	DC
24	24	24
42	48	48
48	110	100
100	120	110
110	208	125
220	220	200
240	240	220
380	380	
400	440	
440	480	
500	600	
550		

※ Non-specified voltage can be available on request.  
For technical information of coil, please refer to page 42, 43.

◆ Accessories

- 1. Front safety cover [UMC100IC](#)  
page 35
- 2. Auxiliary contact block (Front mounting) [UAB](#)  
page 30
- 3. Mechanical latching block [ULB100](#)  
page 33
- 4. Electronic timer block [UET](#)  
page 34
- 5. Surge absorber [URC/UCD](#)  
page 35

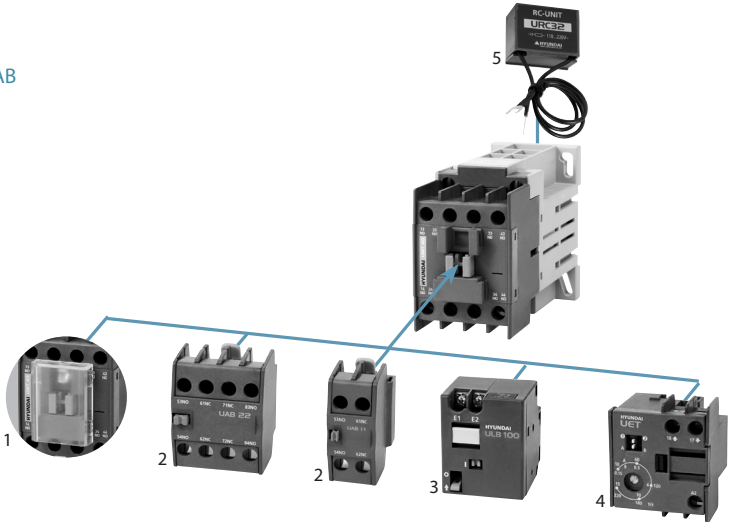

◆ Operating characteristics

Model	Auxiliary contacts	Voltage band		Operating time (msec)			
		Pick-up	Drop-out	On operation		Off operation	
				NO contact (On)	NC contact (Off)	NO contact (Off)	NC contact (On)
UMX (AC220V, 60Hz)	22	115-130	70-85	15-25	5-15	7-17	15-25
	40	130-145	70-85	13-23	-	7-17	-
	44 <sup>1)</sup>	115-130	75-90	13-23	5-15	7-17	13-23
	80 <sup>2)</sup>	135-148	75-95	13-23	-	7-17	-
UMT (DC110V)	22	50-65	12-23	40-50	28-38	10-15	16-28
	40	53-68	12-20	38-48	-	10-20	-
	44 <sup>3)</sup>	50-65	13-25	35-45	25-35	8-18	15-25
	80 <sup>4)</sup>	50-65	13-25	35-45	-	10-20	-

※ 1) UMX04+UAB40 or UMX40+UAB04    2) UMX40+UAB40  
 3) UMT04+UAB40 or UMT40+UAB04    4) UMT40+UAB40

◆ Order information

UMX		22		N		S		X220		
Model / Code	Operation	Code	Auxiliary contact	Code	Application	Code	Terminal accessory	Code	Voltage (V)	Current, frequency
									UMX	AC
UMT	DC	13	1NO+3NC					A <sup>1)</sup>	24-600	AC, 60Hz
		22	2NO+2NC					D <sup>2)</sup>	24-220	DC
		31	3NO+1NC							
		40	4NO+0NC							

※ 1) for UMX  
 2) for UMT

◆ Standard order code and unit

Model	AC220V, 50Hz		AC220V, 60Hz		Model	DC110V		Category	
	Code	Unit	Code	Unit		Code	Unit		
UMX04	UMX 04NS X220	50	UMX 04NS A220	50	UMT04	UMT 04NS D110	25	MC	C8
UMX13	UMX 13NS X220	50	UMX 13NS A220	50	UMT13	UMT 13NS D110	25		
UMX22	UMX 22NS X220	50	UMX 22NS A220	50	UMT22	UMT 22NS D110	25		
UMX31	UMX 31NS X220	50	UMX 31NS A220	50	UMT31	UMT 31NS D110	25		
UMX40	UMX 40NS X220	50	UMX 40NS A220	50	UMT40	UMT 40NS D110	25		

## Accessories

### Auxiliary contact block | UAB, UAL

◆ Order information



UAB		
Model / Code	Applicable product	Mounting position
UAB	UMC9-100 UMX, UMT	Front
UAL	UMC9-800	Side

※ When side mounting auxiliary contact block (UAL) is required without mechanical interlock unit, the block shall be installed on both left and right side together.

22		N		S	
Code	Auxiliary contact	Code	Application	Code	Terminal accessory
02	0NO+2NC	N	Standard	S	Safety cover
11	1NO+1NC	H	Hoist		
20	2NO+0NC				
04	0NO+4NC				
13	1NO+3NC				
22	2NO+2NC				
31	3NO+1NC				
40	4NO+0NC				
65 <sup>1)</sup>	1NO+1NC				
100 <sup>1)</sup>	1NO+1NC				
400	1NO+1NC				

※ 4NC is the maximum NC contact number in combination with the auxiliary contact of applicable product.  
1) UAL65 and UAL100 can be applicable to hoist application.

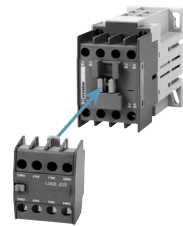
◆ Standard order code and unit

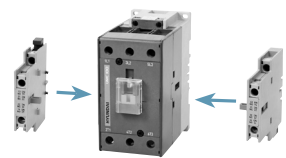
Model	Order information		Specification				Category			
	Code	Unit	Auxiliary contact	Weight (kg)	Applicable product	Mounting position				
 <p>UAB</p>	UAB02	UAB02NS	240	0NO+2NC	0.031	UMC9-100 UMX, UMT	Front		MC	C9
	UAB11	UAB11NS	240	1NO+1NC	0.031					
	UAB20	UAB20NS	240	2NO+0NC	0.031					
	UAB04	UAB04NS	120	0NO+4NC	0.053					
	UAB13	UAB13NS	120	1NO+3NC	0.053					
	UAB22	UAB22NS	120	2NO+2NC	0.053					
	UAB31	UAB31NS	120	3NO+1NC	0.053					
	UAB40	UAB40NS	120	4NO+0NC	0.053					
 <p>UAL</p>	UAL65	UAL65NS	350	1NO+1NC	0.028	UMC9-65	Side			
	UAL100	UAL100NS		1NO+1NC	0.053	UMC75-100				
	UAL400	UAL400NS		1NO+1NC	0.042	UMC115-800				

◆ Ratings

• UAB

Rated insulation voltage [Ui]		V	AC690 (IEC), AC600 (UL)	
Rated thermal current [Ith]		A	16	
Rated current [Ie]	AC15 (Coil load)	AC120V	6	
		AC240V	4	
		AC380V	3	
		AC440V	3	
		AC500V	3	
	DC13 (Coil load)	AC690V	2	
		DC24V	6	
		DC48V	2.8	
		DC120V	1.1	
		DC240V	0.55	
		A	DC480V	0.31
			DC600V	0.2

• UAL

IEC60947

Rated insulation voltage [Ui]		V	AC750	
Rated thermal current [Ith]		A	16	
Rated current [Ie]	AC12 (Resistive load)	AC110V	10	
		AC220V	8	
		AC440V	6	
		AC690V	2	
	AC15 (Coil load)	AC110V	6	
		AC220V	6	
		AC440V	3	
		AC690V	2	
	Hoist application <sup>1)</sup> (NO contact only)	AC220V	A	10
	DC12 (Resistive load)	DC24V	A	5
		DC48V		3
		DC110V		2.5
		DC220V		1
	DC13 (Coil load)	DC24V	A	3
		DC48V		2
DC110V		1		
DC220V		0.6		

※ 1) UAL65 and UAL100 are applicable.

UL & CSA

Rated thermal current [Ith]		A	16
Rated current [Ie]	AC	120V	6
		240V	3
		480V	1.5
		600V	1.2
	DC	125V	1.1
		250V	0.55
		440V	0.31
		600V	0.2

◆ Contact arrangement

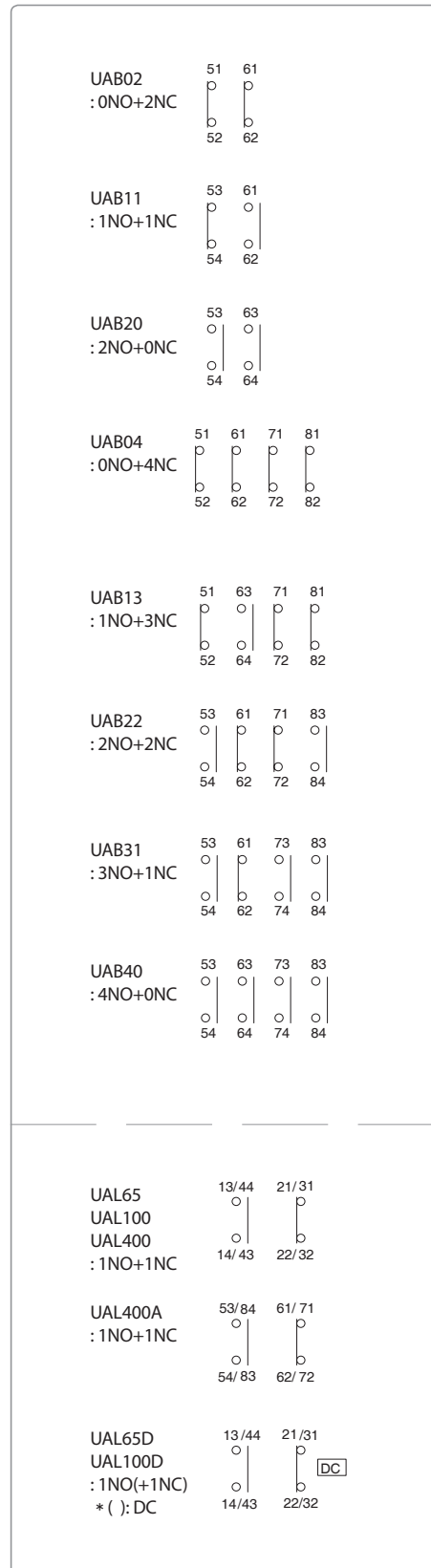

## Accessories

### Mechanical interlock unit | UTL

◆ Mechanical interlock unit provides reliable interlocking between two contactors for reverse operation.

◆ **Handling**

- Mechanical interlock unit must be installed on contactors directly without side mounting auxiliary contact block. If side mounting auxiliary contact blocks are installed on contactors, the inner side blocks must be removed.
- When side mounting auxiliary contact block is required, two blocks can be installed on both outer sides of contactors.
- Mechanical interlock unit must be installed vertically.
- Electrical interlock should be applied via NC contacts of UTL65 for UMC9-65 contactor or side mounting auxiliary contact blocks (UAL) for UMC75-800.
- Simultaneous closing by excessive force may cause damage.

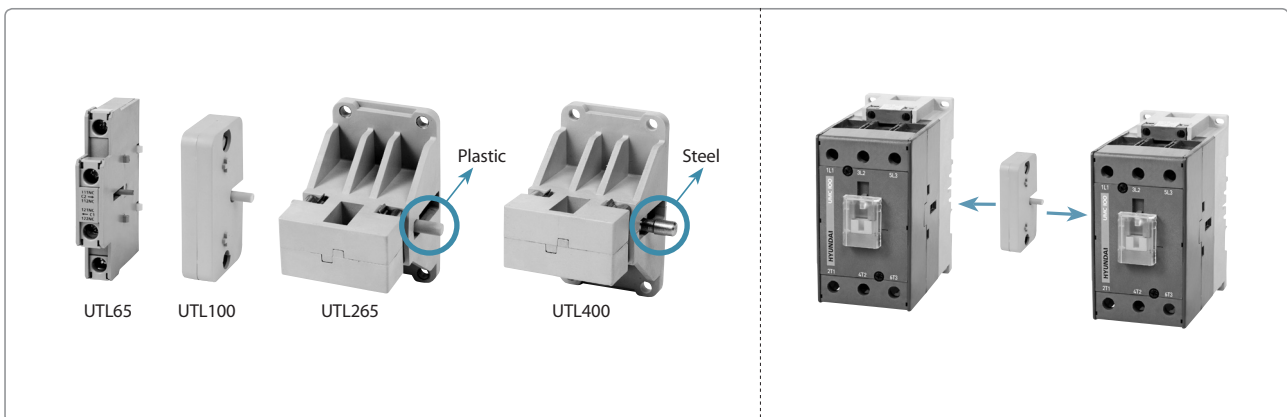

◆ **Order information**

Model	Order information		Specification		Category	
	Code	Unit	Applicable contactor	Weight (kg)		
UTL	UTL65 <sup>1)</sup>		UMC9-65 <sup>2)</sup>	0.042	MC	CB
	UTL100		UMC75-100 <sup>2)</sup>	0.019		
	UTL265		UMC115-265	0.081		
	UTL400		UMC300-800	0.101		

※ 1) 2NC contacts are included.

2) Not applicable to UMC40-100 DC control voltage contactor.



## Mechanical latching block | ULB

- ◆ Mechanical latching block keeps the contactor and control relay mechanically latched in the event of instant control power out or voltage drop, so they can keep ON status.
- ◆ Mechanical latching block starts to latch the contactor or control relay when it is energized, and keep latching during the drop-out of contactor or control relay. The mechanical latching can be released electrically or manually.



### ◆ Handling

#### • How to OFF

- Electrical: Put power to the mechanical latching block.
- Manual: Push up the lever to "O" position.

#### • How to ON

- Electrical: Put the control power to contactor or control relay.
- Manual: Push down the bridge at "I" until mechanically latched.

#### • Caution

- Mechanical latching block must not receive control power for more than 1 sec.
- It is not allowed to put the control power on contactor (or control relay) and mechanical latching block at the same time.



### ◆ Ratings

Power consumption	VA	25
	W	20
Rated voltage	V	AC 24, 48, 100-125, 200-240, 440
		DC 24, 48, 100-125, 200-240
Operation voltage	V	$(0.85-1.1) \times U_c$
Operating frequency	times	1,200
Mechanical lifetime	times	500,000
Weight	kg	0.1

### ◆ Wiring diagram

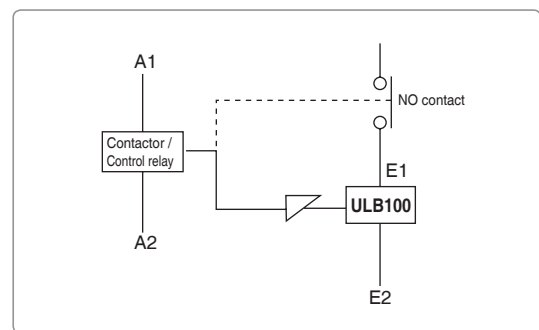

※ A1/A2: Coil terminal  
E1/ E2: Mechanical latching block terminal

### ◆ Order information

Model	Order information		Specification			Category	
	Code	Unit	Current	Operation voltage (V)	Applicable product		
ULB100	ULB100 F024	96	AC/DC	24	UMC9-100 UMX UMT	MC	CA
	ULB100 F048	96		48			
	ULB100 F110	96		100-125			
	ULB100 F220	96		200-240			
	ULB100 A440	96	AC	440			

## Accessories

### Electronic timer block | UET

- ◆ Both ON-delay and interval functions are furnished on the electronic timer block.
- ◆ Wide voltage band of both AC and DC is applicable.
- ◆ Because of its accuracy and multi-functions, the electronic timer block is suitable for various applications including Y-Δ starter.



◆ Order information

Order information		Applicable product	Voltage band	Category	
Code	Unit			MC	CA
UET1		UMC9-100, UMX, UMT	AC/DC90-240V	MC	CA
UET2			AC/DC24-60V		



◆ Ratings

Code		UET1	UET2
Voltage band	V	AC/DC90-240	AC/DC24-60
Operation voltage	V	$(0.8-1.1) \times \text{Voltage band}$	
Breaking capacity	VA	90	
Maximum load	VA	15	
Function	Position ①	ON-delay	
	Position ②	Interval	
Delay time	Position A	10-220sec	
	Position B	0.15-15sec	
Precision	%	±5	
Error rating	%	0.1	
	ms	50	
Weight	kg	0.053	

◆ Function charts

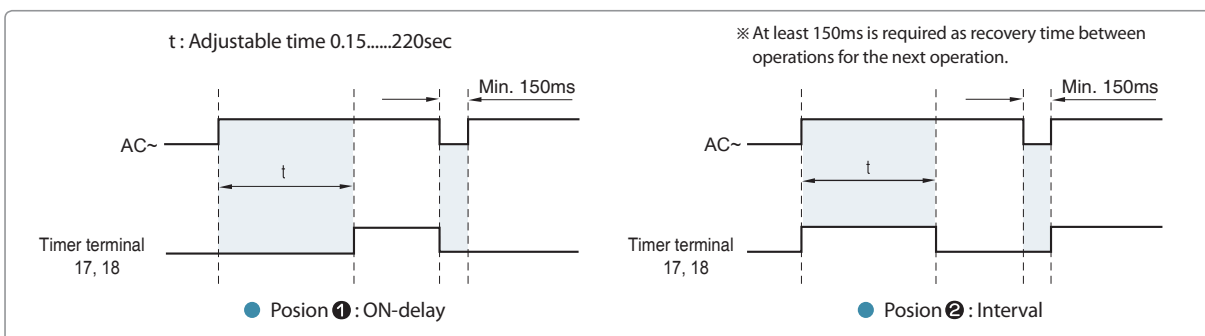

Surge absorber | URC, UCD

- ◆ Damage from high surge voltage can be prevented by surge absorber.
- ◆ Surge absorber limits the surge voltage below 3 times of rated voltage. Surge voltage occurs during the operation of contactor or control relay, and it can be 10-20 times of rated voltage.
- ◆ Surge absorber is required on accurate control circuit, especially for PLC circuit.



Item	Order information		Specification				Category	
	Code	Unit	Operation voltage	Frequency	Applicable product	Weight (kg)		
RC-unit	URC32 Y048		AC24-48V	50/60Hz	UMC9-32, UMX	0.029	MC	CA
	URC32 Y220		AC110-220V					
	URC32 Y380		AC240-380V					
	URC100 Y048		AC24-48V	50/60Hz	UMC40-100			
	URC100 Y220		AC110-220V					
	URC100 Y380		AC240-380V					
Clamping diode	UCD100		DC24-125V	-	UMT			

◆ Wiring diagram

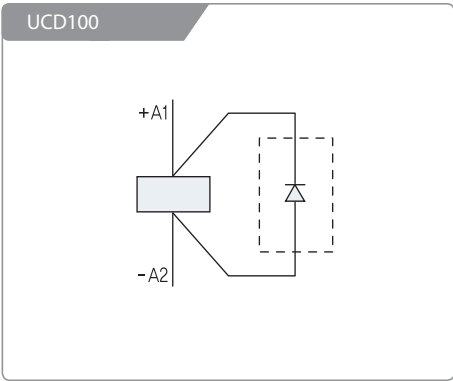
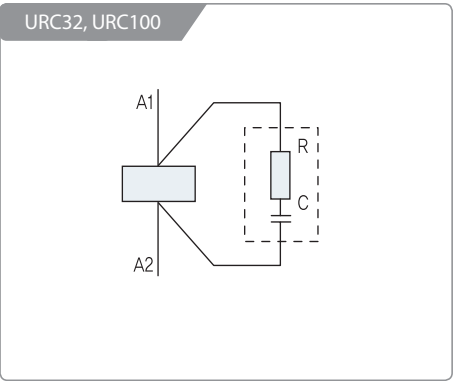

Front safety cover | UMC\_IC

Image	Order information		Applicable product	Category	
	Code	Unit			
	UMC100IC		UMC9-100, UMX, UMT	MC	CD
	UMC150IC		UMC115-150		
	UMC265IC		UMC185-265		
	UMC400IC		UMC300-500		
	UMC800IC		UMC630-800		

## Spare Part

### Coil | UMCOL

◆ Order information

UMCOL	
Code	Description
UMCOL	Coil for contactor and control relay

12	
Code	Applicable product
12	UMC9-12, UMX, UMT
32	UMC18-32
65	UMC40-65
100	UMC75-100
150	UMC115-150
265	UMC185-265
400	UMC300-500
800	UMC630-800

X220		
Code	Voltage (V)	Current, frequency
X	24-550	AC, 50Hz
A	24-600	AC, 60Hz
D	24-220	DC
F	24-240	AC/DC

※ For applicable voltage to each coil, please refer to below operation voltage table.

◆ Standard order code

Code	Applicable product	Voltage	Category	
UMCOL12 X220	UMC9-12, UMX	AC220V, 50Hz	MC	CC
UMCOL32 X220	UMC18-32	AC220V, 50Hz		
UMCOL65 X220	UMC40-65	AC220V, 50Hz		
UMCOL100 X220	UMC75-100	AC220V, 50Hz		
UMCOL12 D110	UMC9-12, UMT	DC110V		
UMCOL32 D110	UMC18-32	DC110V		
UMCOL65 D110	UMC40-65	DC110V		
UMCOL100 D110	UMC75-100	DC110V		
UMCOL150 F220	UMC115-150	AC/DC220V		
UMCOL265 F220	UMC185-265	AC/DC220V		
UMCOL400 F220	UMC300-500	AC/DC220V		
UMCOL800 F220	UMC630-800	AC/DC220V		



◆ Operation voltage

(Unit: V)

Model	AC, 50Hz	AC, 60Hz	DC	AC/DC	Voltage band
UMCOL12 UMCOL32 UMCOL65 UMCOL100	24	24	24		
	42	48	48		
	48	100	60		
	80	110	80		
	100	120	100		
	110	208	110		
	120	220	125		
	220	230	200		
	230	240	220		
	240	277	250		
UMCOL150 UMCOL265	380	380		24	AC: 24-26 DC: 24
	400	440		48	AC: 44-52 DC: 48
	415	460		220	AC: 100-240 DC: 110-220
	440	480		440	AC: 380-450
UMCOL400 UMCOL800				220	AC: 100-240 DC: 110-220
				440	AC: 380-450

※ Non-specified voltage can be available on request. For technical information of coil, please refer to page 42, 43.

### Arc chute | UMCHT

	Order code	Applicable product	Composition	Category	
	UMCHT100	UMC75-100	6EA	MC	CD
	UMCHT150	UMC115-150			
	UMCHT265	UMC185-265			
	UMCHT400	UMC300-400			

### Main contact | UMCTIP

 <p>Moving contacts</p> <p>Fixed contacts</p>	Order code	Applicable product	Composition	Category	
	UMCTIP9	UMC9	Moving contact: 3EA Fixed contact: 6EA	MC	CD
	UMCTIP12	UMC12			
	UMCTIP18	UMC18			
	UMCTIP25	UMC25			
	UMCTIP32	UMC32			
	UMCTIP40	UMC40			
	UMCTIP50	UMC50			
	UMCTIP65	UMC65			
	UMCTIP75	UMC75			
	UMCTIP85	UMC85			
	UMCTIP100	UMC100			
	UMCTIP115	UMC115			
	UMCTIP130	UMC130			
	UMCTIP150	UMC150			
	UMCTIP185	UMC185			
	UMCTIP225	UMC225			
	UMCTIP265	UMC265			
	UMCTIP300	UMC300			
	UMCTIP400	UMC400			
UMCTIP500	UMC500				
UMCTIP630	UMC630				
UMCTIP800	UMC800				

### Terminal protection cover | UMC\_PC

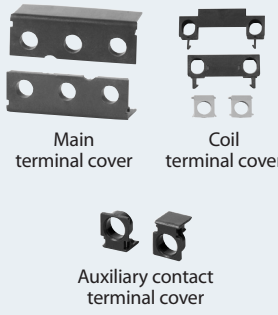
 <p>Main terminal cover</p> <p>Coil terminal cover</p> <p>Auxiliary contact terminal cover</p>	Order code	Applicable product	Composition	Category	
	UMC12PC	UMC9-12	Main terminal cover: 2EA Coil terminal cover: 1EA Auxiliary contact terminal cover: 8EA (UMC115-800)	MC	CD
	UMC32PC	UMC18-32			
	UMC65PC	UMC40-65			
	UMC100PC	UMC75-100			
	UMC150PC	UMC115-150			
	UMC265PC	UMC185-265			
	UMC400PC	UMC300-500			
UMC800PC	UMC630-800				

## Technical Information

The contactors can be selected according to rated thermal current(Ith), rated operating current(Ie), making & breaking capacities, electrical & mechanical endurance, and utilization category.

### ◆ Utilization categories of IEC 60947

AC1	Non-inductive or slightly inductive loads, resistance furnaces	DC1	Non-inductive or slightly inductive loads, resistance furnaces
AC2	Slip-ring motors: starting, plugging	DC3	Shunt motors: plugging, inching
AC3	Squirrel cage motors: starting, switching off motors during running	DC5	Series motors: plugging, inching
AC4	Squirrel cage motors: plugging, inching	DC12	Resistive heating loads
AC12	Resistive heating loads	DC13	Coil loads
AC15	Coil loads		

### ◆ Making and breaking capacities according to utilization categories

Category	Making				Making & breaking			
	Current	Voltage	Cos $\phi$	Number of operations	Current	Voltage	Cos $\phi$	Number of operations
AC1	-	-	-	-	1.5Ie	1.05Ue	0.8	50
AC2	-	-	-	-	4.0Ie	1.05Ue	0.65	50
AC3	10Ie	Ue	0.45 ( $\leq 100A$ )	50	8.0Ie	1.05Ue	0.45 ( $\leq 100A$ )	50
AC4	12Ie	Ue	0.35 ( $> 100A$ )	50	10.0Ie	1.05Ue	0.35 ( $> 100A$ )	50
DC1	-	-	-	-	1.5Ie	1.05Ue	1.0	50
DC3	-	-	-	-	4.0Ie	1.05Ue	2.5	50
DC5	-	-	-	-	4.0Ie	1.05Ue	15	50
AC15	-	-	-	-	10Ie	1.1Ue	0.3	10
DC13	-	-	-	-	1.1Ie	1.1Ue	6P	10

### ◆ Operating times according to utilization categories

Category	Making & breaking				
	Current	Voltage	Cos $\phi$	On-time	Number of operations
AC1	1.0Ie	1.05Ue	0.8	0.05sec	6,000
AC2	2.0Ie	1.05Ue	0.65	0.05sec	6,000
AC3	2.0Ie	1.05Ue	0.45 ( $I_e \leq 100A$ )	0.05sec	6,000
AC4	6.0Ie	1.05Ue	0.35 ( $I_e > 100A$ )	0.05sec	6,000
DC1	1.0Ie	1.05Ue	1.0	0.05sec	6,000
DC3	2.5Ie	1.05Ue	2.0	0.05sec	6,000
DC5	2.5Ie	1.05Ue	7.5	0.05sec	6,000
AC15	10Ie	1.1Ue	0.3	0.05sec	6,000
DC13	1.1Ie	1.1Ue	6P	0.05sec	6,000

### ◆ Electrical characteristics according to utilization categories

Category	Making			Breaking		
	Current	Voltage	Cos $\phi$	Current	Voltage	Cos $\phi$
AC1	1Ie	1Ue	0.95	1Ie	1Ue	0.95
AC2	2.5Ie	1Ue	0.65	2.5Ie	1Ue	0.65
AC3	6Ie	1Ue	0.65 ( $I_e \leq 17A$ )	1Ie	0.17Ue	0.65 ( $I_e \leq 17A$ )
AC4	6Ie	1Ue	0.35 ( $I_e > 17A$ )	6Ie	1Ue	0.35 ( $I_e > 17A$ )
DC1	1Ie	1Ue	1	1Ie	1Ue	1
DC3	2.5Ie	1Ue	2	2.5Ie	1Ue	2
DC5	2.5Ie	1Ue	7.5	2.5Ie	1Ue	7.5

※ Ie: Rated current Ue: Rated voltage

◆ Selection of AC3 & AC4 contactors

- When the frequency of operation is lower than the recommendation, motor output can be increased, but should not exceed the making and breaking capacities of the contactor. If thermal overload relay is used, the short-circuit protection should be carefully considered and the recommended fuse ratings should not be exceeded.
- The contactors can be chosen considering the electrical lifetime by means of the diagrams.
- The electrical lifetime of the contactor for AC3, AC4 duty can be calculated using this formula.

$$L = \frac{1}{P1/L1 + P2/L2 + \dots + Pn/Ln}$$

- L : Electrical lifetime of contactor
- L1 : Electrical lifetime in AC3 duty
- L2 : Electrical lifetime in AC4 duty
- P1 : Coefficient of use in AC3 duty
- P2 : Coefficient of use in AC4 duty
- P1 + P2 + ... + Pn = 1

※ Example of UMC100  
 Motor: 80A full load current at AC440V, 480A starting current (6 times of rated current)  
 AC3 use: 70A rated current with 95% coefficient  
 AC4 use: 70A rated current (420A starting current) with 5% coefficient

$$L \text{ (electrical lifetime)} = \frac{1}{0.95/2.0 \times 10^6 + 0.05/0.03 \times 10^6} = 0.47 \times 10^6$$

- On AC3 electrical lifetime curve, the lifetime of UMC100 is  $2.0 \times 10^6$
- On AC4 electrical lifetime curve, the lifetime of UMC100 is  $0.03 \times 10^6$

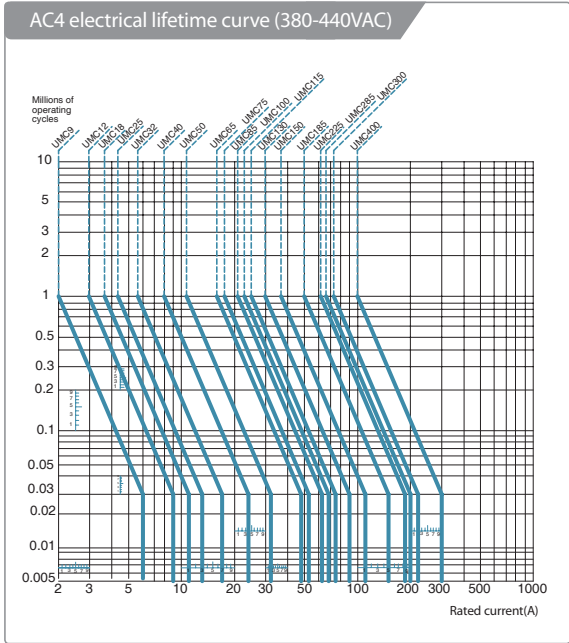
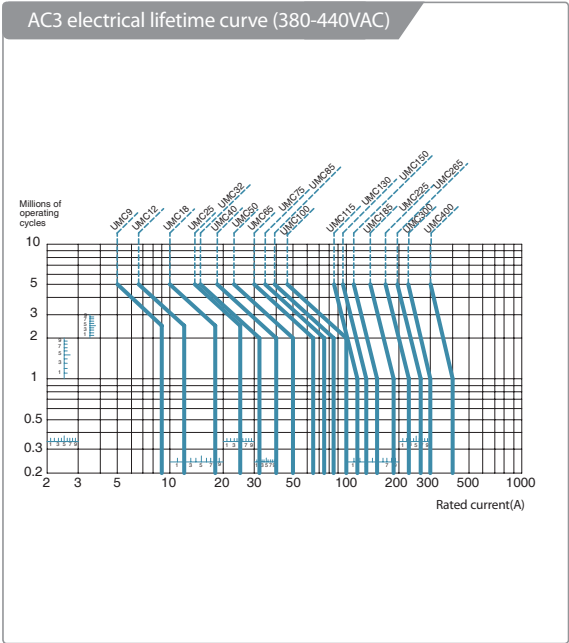

※ Starting current must be less than 6 times of rated current.

# Technical Information

## ◆ Voltage, current & torque of Y-Δ starting

Starting method	Starting (Star-use contactor)				Operating (Delta-use contactor / C2)		
	Starting current	Torque	Full load current	Contact voltage	Full load current	Contact current	Contact voltage
Direct	6Im	1.5T	6Im	$E_m/\sqrt{3}$	Im	Im	$E_m/\sqrt{3}$
Star-delta	2Im	0.5T	2Im	$E_m/\sqrt{3}$	Im	$Im/\sqrt{3}$	Em

※ Im: Delta wiring load current Em: Line-to line voltage T: Rated torque (assumed torque fluctuations)

## ◆ Contactor and thermal overload relay for normal Y-Δ starter

AC200-240V, 3 ∅, 60Hz						
Motor capacity			Main circuit (C1)	Δ circuit (C2)	Y circuit (C3)	Thermal overload relay
kW	HP	FLC <sup>1)</sup>				
5.5	7.5	22	UMC25	UMC25	UMC18	UTH32K
7.5	10	32	UMC32	UMC32	UMC25	UTH32K
11	15	40	UMC40	UMC40	UMC32	UTH65K
15	20	50	UMC50	UMC50	UMC32	UTH65K
18.5	25	70	UMC50	UMC50	UMC40	UTH65K
22	30	80	UMC65	UMC65	UMC40	UTH65K
30	40	110	UMC100	UMC100	UMC50	UTH100K
37	50	130	UMC115	UMC115	UMC65	UTH150K
45	60	150	UMC130	UMC130	UMC65	UTH150K
55	75	180	UMC150	UMC150	UMC100	UTH150K
75	100	260	UMC185	UMC185	UMC115	UTH265K
90	125	300	UMC225	UMC225	UMC130	UTH265K
110	150	367	UMC300	UMC300	UMC150	UTH400K
132	180	434	UMC400	UMC400	UMC225	UTH400K
160	220	519	UMC400	UMC400	UMC225	UTH400K
250	350	810	UMC630	UMC630	UMC400	UTH800K
300	-	-	-	-	-	-

AC380-440V, 3 ∅, 60Hz						
Motor capacity			Main circuit (C1)	Δ circuit (C2)	Y circuit (C3)	Thermal overload relay
kW	HP	FLC <sup>1)</sup>				
5.5	7.5	12	UMC25	UMC25	UMC25	UTH32K
7.5	10	18	UMC25	UMC25	UMC25	UTH32K
11	15	22	UMC25	UMC25	UMC25	UTH32K
15	20	32	UMC32	UMC32	UMC25	UTH32K
18.5	25	40	UMC40	UMC40	UMC25	UTH65K
22	30	50	UMC40	UMC40	UMC32	UTH65K
30	40	65	UMC50	UMC50	UMC40	UTH65K
37	50	80	UMC65	UMC65	UMC40	UTH65K
45	60	90	UMC65	UMC65	UMC40	UTH65K
55	75	110	UMC100	UMC100	UMC50	UTH100K
75	100	150	UMC115	UMC115	UMC65	UTH150K
90	125	180	UMC130	UMC130	UMC100	UTH150K
110	150	220	UMC150	UMC150	UMC115	UTH150K
132	180	260	UMC185	UMC185	UMC115	UTH265K
160	220	300	UMC225	UMC225	UMC130	UTH265K
250	350	500	UMC400	UMC400	UMC225	UTH400K
300	402	560	UMC400	UMC400	UMC300	UTH400K

※ - Above data are based on squirrel cage motor (AC3) and slip-ring motor (AC2). Data are subject to change according to motor classes and motor manufacturers.  
 - Above data are based on less than 10 seconds motor starting time. Motor starting time must be considered when over 10 seconds motor starting time is applied.  
 - Inrush current shall be considered when a capacitor is used.  
 - Recommendable change-over time from Y-Δ is between 30ms and 80ms.  
 - 58% of motor full load current is recommended for UTH setting current.  
 1) FLC: Full load current.

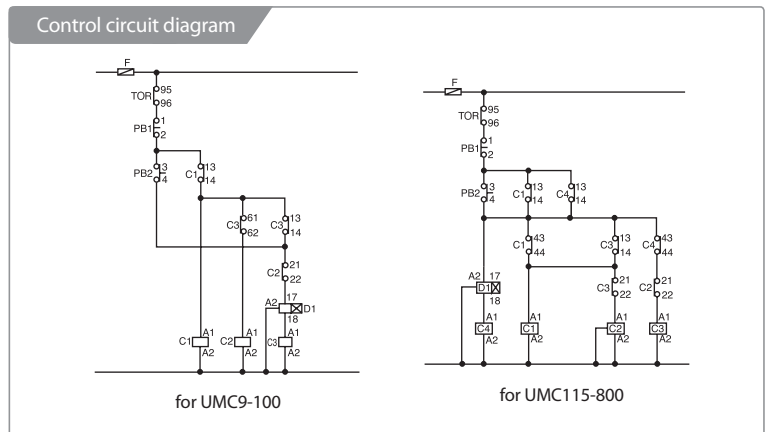
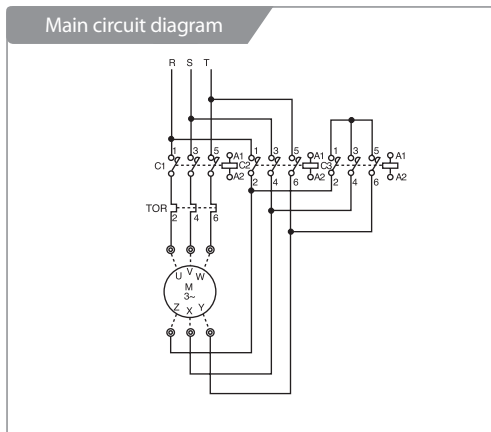

※ C1: Main contactor C2: Delta contactor C3: Star contactor D1: Electronic timer block C4: Control relay



◆ Inching & plugging duty AC4 utilization category

(Unit: kW)

Operation	Voltage	Ratio	Electrical lifetime	UMC9	UMC12	UMC18	UMC25	UMC32	UMC40	UMC50	UMC65	UMC75	UMC85	UMC100	
Inching	AC220V	10%	100,000	2.2	2.7	3.7	4	5.5	7.5	11	15	18.5	19.0	25	
			500,000	1	1.5	2.7	3.7	4.5	5.5	7.5	11	15	15	15	
		50%	100,000	1	1.5	2.7	3.7	4.5	5.5	7.5	11	15	15	15	19
			500,000	0.5	0.75	1.1	1.5	2.2	3.7	3.7	5.5	7.5	7.5	7.5	9
		100%	100,000	0.75	1.1	1.5	2.5	4.5	4.5	5.5	7.5	9	9	11	11
			500,000	0.3	0.5	0.75	1.1	1.8	2.7	3.7	4	4	5.5	5.5	5.5
	AC440V	10%	100,000	2.7	4	4	7.5	11	15	22	30	37	37	37	50
			500,000	1.5	2.2	3.7	7.5	9	11	15	22	30	30	30	37
		50%	100,000	1.5	3.7	4	7.5	9	11	15	22	30	30	30	37
			500,000	0.75	1.5	2.2	3.7	4.5	5.5	7.5	11	15	15	15	18.5
		100%	100,000	1.1	2.2	3.7	5.5	7.5	11	15	15	15	15	22	25
			500,000	0.5	1.1	1.5	2.2	3.7	3.7	5.5	7.5	7.5	7.5	11.0	13
Plugging	AC220V	100%	100,000	0.75	0.75	1.5	2.2	2.5	3.7	5.5	7.5	9	9	11	
			500,000	0.2	0.4	0.5	0.75	1.1	1.5	22	3	3.7	3.7	4.5	
	AC440V		100,000	0.75	1	2.2	3.7	4.5	4.5	7.5	11	18.5	18.5	22.0	
			500,000	0.2	0.4	0.75	1.5	2.2	2.2	3.7	5.5	7.5	7.5	11.0	

(Unit: kW)

Operation	Voltage	Ratio	Electrical lifetime	UMC115	UMC130	UMC150	UMC185	UMC225	UMC265	UMC300	UMC400	UMC500	UMC630	UMC800
Inching	AC220V	10%	100,000	30	30	37	45	55	65	75	110	132	160	200
			500,000	15	22	25	30	37	45	50	65	70	75	132
		50%	100,000	22	22	30	37	45	50	55	75	80	90	150
			500,000	9	9	11	15	19	22	25	30	32	37	45
		100%	100,000	11	15	19	25	30	32	37	45	50	55	75
			500,000	5.5	7.5	9	11	15	17	22	25	30	37	45
	AC440V	10%	100,000	50	60	75	90	110	132	150	200	250	300	400
			500,000	37	45	55	75	90	110	125	132	140	150	190
		50%	100,000	37	45	55	75	90	110	132	150	167	190	220
			500,000	18.5	22	30	37	37	42	50	75	80	90	110
		100%	100,000	25	30	45	55	60	65	75	110	120	132	160
			500,000	13	15	22	25	30	32	37	55	63	75	90
Plugging	AC220V	100%	100,000	11	15	19	22	25	30	37	45	50	55	75
			500,000	4.5	5.5	7.5	11	13	15	18.5	22	25	30	37
	AC440V		100,000	22	30	37	45	45	49	55	75	90	110	150
			500,000	11	15	19	22	25	26	30	37	40	45	

※ - Ratio of inching operation (%) =  $\frac{\text{Inching operations}}{\text{Standard operations} + \text{Inching operations}} \times 100$

- The inching limit of making & breaking frequency is below the continuous 10 operations based on 1 operation per 1 second.

# Technical Information

## ◆ Coil characteristics

Model					UMC9	UMC12	UMC18	UMC25	UMC32	UMC40	UMC50	UMC65	UMC75	UMC85	
Power consumption	AC & DC coil	AC operation coil (220V/60Hz)	Inrush	VA	80	80	80	80	80	200	200	200	300	300	
			Sealed	VA/W	10/2.5	10/2.5	10/2.5	10/2.5	10/2.5	15/5	15/5	15/5	20/8	20/8	
		DC operation coil	Inrush	W	10	10	10	10	10	200	200	200	200	200	200
			Sealed	W	10	10	10	10	10	5	5	5	8	8	
	AC/DC common coil	AC operation coil (220V/60Hz)	Inrush	VA	-	-	-	-	-	-	-	-	-	-	-
			Sealed	VA/W	-	-	-	-	-	-	-	-	-	-	-
		AC operation coil (110V/60Hz)	Inrush	VA	-	-	-	-	-	-	-	-	-	-	-
			Sealed	VA/W	-	-	-	-	-	-	-	-	-	-	-
		DC operation coil	Inrush	W	-	-	-	-	-	-	-	-	-	-	-
			Sealed	W	-	-	-	-	-	-	-	-	-	-	-
	Operating time	AC & DC coil	Closing (coil ON → contact ON)	AC	ms	12-30	12-30	12-30	12-30	12-30	9-18	9-18	9-18	11-18	11-18
				DC		45-55	45-55	45-55	45-55	45-55	10-18	10-18	10-18	14-20	14-20
AC				-		-	-	-	-	-	-	-	-	-	-
DC				-		-	-	-	-	-	-	-	-	-	-
AC & DC coil		Opening (coil OFF → contact OFF)	AC	8-15		8-15	8-15	8-15	8-15	8-15	4-13	4-13	4-13	6-12	6-12
			DC	6-18		6-18	6-18	6-18	6-18	5-15	5-15	5-15	5-15	5-15	
			AC	-		-	-	-	-	-	-	-	-	-	-
			DC	-		-	-	-	-	-	-	-	-	-	-
AC/DC common coil			AC	-		-	-	-	-	-	-	-	-	-	-
			DC	-		-	-	-	-	-	-	-	-	-	-
Control transformer		AC or DC coil	Min. capacity	VA		60	60	60	60	60	150	150	150	200	200
		AC/DC common coil				-	-	-	-	-	-	-	-	-	-

Model					UMC100	UMC115	UMC130	UMC150	UMC185	UMC225	UMC265	UMC300	UMC400	UMC500	UMC630	UMC800	
Power consumption	AC & DC coil	AC operation coil (220V/60Hz)	Inrush	VA	300	-	-	-	-	-	-	-	-	-	-	-	
			Sealed	VA/W	20/8	-	-	-	-	-	-	-	-	-	-	-	
		DC operation coil	Inrush	W	200	-	-	-	-	-	-	-	-	-	-	-	-
			Sealed	W	8	-	-	-	-	-	-	-	-	-	-	-	-
	AC/DC common coil	AC operation coil (220V/60Hz)	Inrush	VA	-	290	290	290	360	360	360	380	380	380	1,700	1,700	
			Sealed	VA/W	-	7.4/3.8	7.4/3.8	7.4/3.8	9.3/5.8	9.3/5.8	9.3/5.8	9.3/5.8	9.3/5.8	9.3/5.8	17.1/10.6	17.1/10.6	
		AC operation coil (110V/60Hz)	Inrush	VA	-	180	180	180	240	240	240	250	250	250	850	850	
			Sealed	VA/W	-	3.3/2.1	3.3/2.1	3.3/2.1	6.4/4.4	6.4/4.4	6.4/4.4	6.4/4.4	6.4/4.4	6.4/4.4	10.5/8	10.5/8	
		DC operation coil	Inrush	W	-	193	193	193	234	234	234	234	234	234	234	850	850
			Sealed	W	-	2.3	2.3	2.3	3.4	3.4	3.4	3.4	3.4	3.4	3.4	9.5	9.5
	Operating time	AC & DC coil	Closing (coil ON → contact ON)	AC	ms	11-18	-	-	-	-	-	-	-	-	-	-	-
				DC		14-20	-	-	-	-	-	-	-	-	-	-	
AC				-		40-80	40-80	40-80	25-45	25-45	25-45	25-40	25-40	25-40	45-150	45-150	
DC				-		70-80	70-80	70-80	35-45	35-45	35-45	35-45	35-45	35-45	45-150	45-150	
AC & DC coil		Opening (coil OFF → contact OFF)	AC	6-12		-	-	-	-	-	-	-	-	-	-	-	-
			DC	5-15		-	-	-	-	-	-	-	-	-	-	-	
			AC	-		18-25	18-25	18-25	40-50	40-50	40-50	35-50	35-50	35-50	45-150	45-150	
			DC	-		15-20	15-20	15-20	35-45	35-45	35-45	35-45	35-45	35-45	45-150	45-150	
Control transformer		AC or DC coil	Min. capacity	VA		200	-	-	-	-	-	-	-	-	-	-	-
		AC/DC common coil				-	200	200	200	200	200	200	200	200	200	1,000	1,000

※ The operating time of UMC115-400 is the average value of AC220V, 60Hz and DC110V.

◆ Control coil voltage

(Unit: V)

Model	AC, 50Hz	AC, 60Hz	DC	Remark
UMC9 UMC12 UMC18 UMC25 UMC32 UMC40 UMC50 UMC65 UMC75 UMC85 UMC100	24	24	24	1) Rated current should be applied to the contactor coil. 2) Applicable voltage: 85-110% 3) Keep applying out bound applicable voltage could shorten the coil lifetime. 4) If out of applicable voltage is applied to the coil, it could cause short coil lifetime, coil burnt-out, and even fire.
	42	48	48	
	48	100	60	
	80	110	80	
	100	120	100	
	110	208	110	
	120	220	125	
	220	230	200	
	230	240	220	
	240	277	250	
	380	380		
	400	440		
	415	460		
440	480			

(Unit: V)

Model	AC/DC		Remark
		Voltage band	
UMC115 UMC130 UMC150 UMC185 UMC225 UMC265	24	AC: 24-26 DC: 24	1) Rated current should be applied to the contactor coil. 2) Applicable voltage: 85-110% 3) Keep applying out bound applicable voltage could shorten the coil lifetime. 4) If out of applicable voltage is applied to the coil, it could cause short coil lifetime, coil burnt-out, and even fire.
	48	AC: 44-52 DC: 48	
	220	AC: 100-240 DC: 110-220	
	440	AC: 380-450	
UMC300 UMC400 UMC500 UMC630 UMC800	220	AC: 100-240 DC: 110-220	
	440	AC: 380-450	

※ Non-specified voltage is available on request.

# Technical Information

## ◆ Auxiliary contact characteristics

IEC60947

Model		UMC9-800		
Rated insulation voltage		V	AC750	
Rated thermal current [Ith]		A	16	
Rated current [Ie]	AC12 (Resistive loads)	AC110V	10	
		AC220V	8	
		AC440V	6	
		AC690V	2	
	AC15 (Coil loads)	AC110V	6	
		AC220V	6	
		AC440V	3	
		AC690V	2	
	Hoist application <sup>1)</sup> (NO contact only)	AC220V	A	10
	DC12 (Resistive loads)	DC24V	A	5
		DC48V		3
		DC110V		2.5
		DC220V		1
	DC13 (Coil loads)	DC24V	A	3
		DC48V		2
		DC110V		1
DC220V		0.6		

1) Hoist application is available for UMC9-100.

UL & CSA

Model		UMC9-800		
Rated thermal current [Ith]		A	16	
Rated current [Ie]	AC	120V	A	6
		240V		3
		480V		1.5
		600V		1.2
	DC	125V	A	1.1
		250V		0.55
		440V		0.31
		600V		0.2

## ◆ Contact arrangement

Contactor and auxiliary block

Model	Item	AC, DC	
UMC9 UMC12	Contactor only		
	Contactor with side mounting auxiliary contact block <sup>1)</sup> (max.)		
UMC18 UMC25 UMC32	Contactor only		
	Contactor with side mounting auxiliary contact block <sup>1)</sup> (max.)		

※ 1) For applicable auxiliary contact block, please refer to page 30, 31.

Model	Item	AC	DC
UMC40 UMC50 UMC65 UMC75 UMC85 UMC100	Contactor only		
	Contactor with side mounting auxiliary contact block <sup>1)</sup> (max.)	<p style="text-align: center;">2NO+2NC</p>	<p style="text-align: center;">2NO+1NC</p>

Model	Item	AC/DC
UMC115 UMC130 UMC150 UMC185 UMC225 UMC265 UMC300 UMC400 UMC500 UMC630 UMC800	Contactor only	<p style="text-align: center;">2NO+2NC</p>
	Contactor with side mounting auxiliary contact block <sup>1)</sup> (max.)	<p style="text-align: center;">4NO+4NC</p>

※ 1) For applicable auxiliary contact block, please refer to page 30, 31.

Control relay

Model	AC, DC
UMX04 UMT04	
UMX13 UMT13	
UMX22 UMT22	
UMX31 UMT31	
UMX40 UMT40	

# Technical Information

◆ DC load rated operation current

Connection	Application	Operation voltage	UMC9	UMC12	UMC18	UMC25	UMC32	UMC40	UMC50	UMC65	UMC75	UMC85	UMC100
2 poles series	DC1 resistive load (L/R≤1ms)	24V	10	12	18	20	25	35	50	65	65	75	80
		48V	10	12	18	20	25	35	40	65	65	65	65
		110V	6	10	13	15	25	25	35	65	65	50	50
		220V	3	7	8	10	12	12	15	50	50	20	20
	DC3, DC5 DC moter load (L/R≤15ms)	24V	8	12	12	20	25	35	45	45	45	65	65
		48V	4	6	6	15	20	20	25	25	25	40	40
		110V	2.5	4	4	8	10	10	15	15	15	20	20
		220V	0.8	1.2	1.2	2	3	3	3.5	3.5	3.5	5	5
	DC13 coil load (L/R≤40ms)	24V	8	12	12	20	25	35	-	-	-	-	-
		48V	4	6	6	12	15	15	-	-	-	-	-
		110V	2	3	3	3	4	4	-	-	-	-	-
		220V	0.3	0.5	0.5	1.2	1.2	1.2	-	-	-	-	-
3 poles series	DC1 resistive load (L/R≤1ms)	24V	10	12	18	20	25	35	50	65	65	75	80
		48V	10	12	18	20	25	35	50	65	65	75	80
		110V	8	12	18	20	25	35	50	65	65	75	80
		220V	8	12	18	20	22	30	40	50	50	55	60
	DC3, DC5 DC moter load (L/R≤15ms)	24V	8	12	12	20	25	35	50	50	50	80	80
		48V	6	10	10	20	25	30	35	35	35	60	60
		110V	4	8	8	15	20	20	30	30	30	50	50
		220V	2	4	4	8	10	10	12	12	12	20	20
	DC13 coil load (L/R≤40ms)	24V	8	12	12	20	25	35	-	-	-	-	-
		48V	6	10	10	15	25	25	-	-	-	-	-
		110V	3	5	5	10	12	12	-	-	-	-	-
		220V	0.8	2	2	4	4	4	-	-	-	-	-

Connection	Application	Operation voltage	UMC115	UMC130	UMC150	UMC185	UMC225	UMC265	UMC300	UMC400	UMC500	UMC630	UMC800
2 poles series	DC1 resistive load (L/R≤1ms)	24V	100	120	150	180	220	260	300	400	500	630	800
		48V	100	100	120	180	180	220	240	240	300	630	800
		110V	80	80	100	150	150	180	200	200	220	630	630
		220V	50	50	100	150	150	180	200	200	220	630	630
	DC3, DC5 DC moter load (L/R≤15ms)	24V	100	120	150	180	220	260	300	400	500	630	800
		48V	60	60	100	150	150	180	200	200	260	630	800
		110V	40	40	80	120	120	130	150	150	180	630	630
		220V	30	30	60	80	80	80	90	90	130	210	210
	DC13 coil load (L/R≤40ms)	24V	-	-	-	-	-	-	-	-	-	-	-
		48V	-	-	-	-	-	-	-	-	-	-	-
		110V	-	-	-	-	-	-	-	-	-	-	-
		220V	-	-	-	-	-	-	-	-	-	-	-
3 poles series	DC1 resistive load (L/R≤1ms)	24V	100	120	150	180	220	260	300	400	500	630	800
		48V	100	120	150	180	220	260	300	400	500	630	800
		110V	100	100	150	180	220	260	300	400	500	630	630
		220V	80	80	150	180	220	260	300	300	400	630	630
	DC3, DC5 DC moter load (L/R≤15ms)	24V	100	120	150	180	220	260	300	400	500	630	800
		48V	90	90	130	180	220	260	280	280	400	630	800
		110V	80	80	120	150	150	180	200	200	260	630	630
		220V	50	50	80	100	100	130	150	150	180	310	310
	DC13 coil load (L/R≤40ms)	24V	-	-	-	-	-	-	-	-	-	-	-
		48V	-	-	-	-	-	-	-	-	-	-	-
		110V	-	-	-	-	-	-	-	-	-	-	-
		220V	-	-	-	-	-	-	-	-	-	-	-

- ※ - DC1 is applied to resistive loads and DC13 is applied to inductive coil loads (IEC 60947).
- DC3 is applied to starting or inching of shunt motors and DC5 is applied to starting or inching of series motors (IEC 60947).
- DC3 and DC5 of making & breaking capacity is 4 times to above table and its operation is 50 times.
- Electrical lifetime is up to 500,000 when the frequency is less than 100 operations per a hour.

#### ◆ Application for transformer and condenser load

Model	Transformer load (kVA)				Condenser load (kVAR)	
	Single phase		Three phase		Three phase	
	AC220V	AC440V	AC220V	AC440V	AC220V	AC440V
UMC9	1	1.5	2	2.5	2	3
UMC12	1.5	2	3	4	3	4
UMC18	2	3	3.5	5	4	6
UMC25	2.5	4	4	7.5	5	10
UMC32	3	5	5	10	9	16
UMC40	4	7.5	6.5	12	11	20
UMC50	5	10	10	18	13	24
UMC65	7	15	12	25	17	34
UMC75	8	17	13	27	20	40
UMC85	9	18	15	30	22	45
UMC100	10	20	18	35	24	48
UMC130	15	25	25	42	29	58
UMC150	17	33	30	60	35	70
UMC185	20	40	35	70	42	84
UMC225	25	50	42	85	58	115
UMC265	30	57	48	95	63	125
UMC300	33	66	57	100	69	139
UMC400	44	90	75	150	92	185
UMC500	55	110	90	180	115	230
UMC630	65	130	110	220	145	291
UMC800	90	175	150	300	185	369

※ - The inrush current of transformer shall be less than 30 times of rated current (RMS).  
 - Electrical lifetime: 100,000 times (IEC60947-4-1, AC6a, 6b)

#### ◆ Lighting load application

The contactor for lighting load can be selected by the rated thermal current (I<sub>th</sub>) on the condition that the inrush current does not exceed the contactor breaking capacity. Usually, lighting load switching frequency is smaller than the other applications, so electrical lifetime would not be the major parameter to select the contactor.

##### Incandescent lamp

The contactor for incandescent lamps can be selected according to AC3 utilization category considering the inrush current at hot condition. The resistance of the incandescent lamp filament is small at cold condition, so the inrush current can be 13-16 times of the rated current instantaneously. However, the inrush current at hot condition is limited to 7-10 times of rated current by circuit impedance and self-heating. Therefore, it is recommended to consider the inrush current at hot condition rather than cold condition to select the contactor.

Maximum incandescent lamp quantity per contactor

(Unit : number of lamp)

Voltage	AC110V								AC220V							
	100W	150W	200W	250W	300W	500W	1,000W	1,500W	100W	150W	200W	250W	300W	500W	1,000W	1,500W
UMC9	11	7	5	4	2	2	1	-	22	14	11	8	7	4	2	1
UMC12	14	8	6	5	4	2	1	-	26	18	14	10	8	5	2	1
UMC18	19	13	10	7	6	3	1	1	38	25	20	15	13	7	3	2
UMC25	20	13	10	8	6	3	1	1	40	27	20	16	13	8	3	2
UMC32	28	18	14	11	9	5	2	1	55	36	28	22	18	11	5	3
UMC40	38	25	19	15	12	7	3	2	75	50	38	30	25	15	7	4
UMC50	55	35	27	22	16	10	5	3	105	70	54	43	35	22	10	6

## Technical Information

### ◆ Applicable cable size & tightening torque

#### Main terminal

Model	Terminal screw	Applicable cable size (mm <sup>2</sup> )	Tightening torque (kgf.cm)
UMC9	M3.5	1.25-5.5	12
UMC12	M3.5	1.25-5.5	12
UMC18	M4	1.25-14	26
UMC25	M4	1.25-14	26
UMC32	M4	1.25-14	26
UMC40	M6	2-22	40
UMC50	M6	2-22	40
UMC65	M6	2-22	40
UMC75	M8	2-38	60
UMC85	M8	2-38	60
UMC100	M8	2-38	60
UMC115	M8	2-60	60
UMC130	M8	2-60	60
UMC150	M8	2-60	60
UMC185	M10	2-150	100
UMC225	M10	2-150	100
UMC265	M10	2-150	100
UMC300	M12	2-240	140
UMC400	M12	2-240	140
UMC500	M12	2-240	140
UMC630	M16	80-325	140
UMC800	M16	80-325	140

#### Coil terminal

Model	Terminal screw	Applicable cable size (mm <sup>2</sup> )	Tightening torque (kgf.cm)
UMC9-100	M3.5	1.25-2	12
UMC115-800			





# Thermal Overload Relay



## Specifications & Order Information

### UTH12-100 | 0.12-100A

Model		UTH12			UTH32			UTH65			UTH100		
Applicable contactor		UMC9 UMC12			UMC18 UMC25 UMC32			UMC40 UMC50 UMC65			UMC75 UMC85 UMC100		
Nominal current		Setting current (A)			Setting current (A)			Setting current (A)			Setting current (A)		
		Min.	Mid.	Max.	Min.	Mid.	Max.	Min.	Mid.	Max.	Min.	Mid.	Max.
0.18		0.12	0.15	0.18	0.12	0.15	0.18						
0.26		0.18	0.22	0.26	0.18	0.22	0.26						
0.35		0.25	0.3	0.35	0.25	0.3	0.35						
0.5		0.34	0.42	0.5	0.34	0.42	0.5						
0.7		0.5	0.6	0.7	0.5	0.6	0.7						
0.9		0.6	0.75	0.9	0.6	0.75	0.9						
1.2		0.8	1	1.2	0.8	1	1.2						
1.6		1.1	1.35	1.6	1.1	1.35	1.6						
2.1		1.5	1.8	2.1	1.5	1.8	2.1						
3		2	2.5	3	2	2.5	3						
4.2		2.8	3.5	4.2	2.8	3.5	4.2						
5		3	4	5	3	4	5						
6		4	5	6	4	5	6						
8		5.6	6.8	8	5.6	6.8	8						
9		6	7.5	9	6	7.5	9						
10								7	8.5	10			
12		8	10	12	8	10	12	8	10	12			
18					12	15	18	12	15	18			
22					15	18.5	22	15	18.5	22			
25					17	21	25	17	21	25	17	21	25
32					22	27	32	22	27	32	22	27	32
40								28	34	40	28	34	40
50								34	42	50	34	42	50
65								45	55	65	45	55	65
75											52	63	75
85											59	72	85
100											70	85	100
Phase protection	K-type	3 element											
	H-type	2 element											
Auxiliary contact		1NO+1NC											
Reset		Manual & Automatic											
Phase loss protection (Differential trip)		K-type only											
Applicable cable (mm <sup>2</sup> )	Main terminal	1-2.5			2-10			2-25			6-38		
	Aux. terminal	1-2.5											
Dimensions (mm)	Width × Height × Depth	45 × 79 × 76			45 × 81 × 91			55 × 94 × 105			70 × 108 × 123		
	Weight (kg, K-type)	0.125			0.165			0.302			0.545		

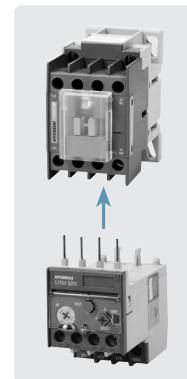

※ UTH makes trip within 2 minutes on 150% overload at hot condition, so the protection class of UTH is 10A.

## ◆ Order information

UTH		100		K		A0100				S	
Code	Series	Code	Applicable contactor	Code	Element	Code	Setting current (A)	Code	Setting current (A)	Code	Terminal accessory
UTH	UTH	12	UMC9-12	K	3	A0P18	0.12-0.18	A0009	6-9	S	Safety cover
		32	UMC18-32	H	2	A0P26	0.18-0.26	A0010	7-10		
		65	UMC40-65			A0P35	0.25-0.35	A0012	8-12		
		100	UMC75-100			A0P50	0.34-0.5	A0018	12-18		
						A0P70	0.5-0.7	A0022	15-22		
						A0P90	0.6-0.9	A0025	17-25		
						A1P20	0.8-1.2	A0032	22-32		
						A1P60	1.1-1.6	A0040	28-40		
						A2P10	1.5-2.1	A0050	34-50		
						A0003	2-3	A0065	45-65		
						A4P20	2.8-4.2	A0075	52-75		
						A0005	3-5	A0085	59-85		
						A0006	4-6	A0100	70-100		
						A0008	5.6-8				

## ◆ Standard order code and unit

Model	Code	Setting current (A)	Unit	Model	Code	Setting current (A)	Unit	Category	
UTH12	UTH12K A0P18S	0.12-0.18	44	UTH32	UTH32K A0P18S	0.12-0.18	40	MC	CF
	UTH12K A0P26S	0.18-0.26	44		UTH32K A0P26S	0.18-0.26	40		
	UTH12K A0P35S	0.25-0.35	44		UTH32K A0P35S	0.25-0.35	40		
	UTH12K A0P50S	0.34-0.5	44		UTH32K A0P50S	0.34-0.5	40		
	UTH12K A0P70S	0.5-0.7	44		UTH32K A0P70S	0.5-0.7	40		
	UTH12K A0P90S	0.6-0.9	44		UTH32K A0P90S	0.6-0.9	40		
	UTH12K A1P20S	0.8-1.2	44		UTH32K A1P20S	0.8-1.2	40		
	UTH12K A1P60S	1.1-1.6	44		UTH32K A1P60S	1.1-1.6	40		
	UTH12K A2P10S	1.5-2.1	44		UTH32K A2P10S	1.5-2.1	40		
	UTH12K A0003S	2-3	44		UTH32K A0003S	2-3	40		
	UTH12K A4P20S	2.8-4.2	44		UTH32K A4P20S	2.8-4.2	40		
	UTH12K A0005S	3-5	44		UTH32K A0005S	3-5	40		
	UTH12K A0006S	4-6	44		UTH32K A0006S	4-6	40		
	UTH12K A0008S	5.6-8	44		UTH32K A0008S	5.6-8	40		
UTH12K A0009S	6-9	44	UTH32K A0009S	6-9	40				
UTH12K A0012S	8-12	44	UTH32K A0012S	8-12	40				
UTH65	UTH65K A0010S	7-10	28	UTH32K A0018S	12-18	40			
	UTH65K A0012S	8-12	28	UTH32K A0022S	15-22	40			
	UTH65K A0018S	12-18	28	UTH32K A0025S	17-25	40			
	UTH65K A0022S	15-22	28	UTH32K A0032S	22-32	40			
	UTH65K A0025S	17-25	28	UTH100	UTH100K A0025S	17-25	10		
	UTH65K A0032S	22-32	28		UTH100K A0032S	22-32	10		
	UTH65K A0040S	28-40	28		UTH100K A0040S	28-40	10		
	UTH65K A0050S	34-50	28		UTH100K A0050S	34-50	10		
UTH65K A0065S	45-65	28	UTH100K A0065S		45-65	10			
			UTH100K A0075S		52-75	10			
			UTH100K A0085S	59-85	10				
			UTH100K A0100S	70-100	10				

## ◆ DIN-rail adaptor

Model	Code	Weight (kg)	Mounting method	Category	
UTHMB	UTHMB12	0.060	Screw & DIN-rail	MC	CB
	UTHMB32	0.079			
	UTHMB65	0.126			
	UTHMB100	0.222			



## Specifications & Order Information

### UTH150-800 | 48-800A (CT operated type)

Model	UTH150			UTH265			UTH400			UTH800			
Applicable contactor	UMC115 UMC130 UMC150			UMC185 UMC225 UMC265			UMC300 UMC400			UMC500 UMC630 UMC800			
Nominal current	Setting current (A)			Setting current (A)			Setting current (A)			Setting current (A)			
	Min.	Mid.	Max.	Min.	Mid.	Max.	Min.	Mid.	Max.	Min.	Mid.	Max.	
80 (CT 80:5)	48	64	80	48	64	80							
115 (CT 115:5)	69	92	115	69	92	115							
130 (CT 130:5)	78	104	130	78	104	130							
150 (CT 150:5)	90	120	150	90	120	150	90	120	150				
185 (CT 185:5)				111	148	185	111	148	185				
225 (CT 225:5)				135	180	225	135	180	225				
265 (CT 265:5)				159	212	265	159	212	265				
300 (CT 300:5)							180	240	300				
400 (CT 400:5)							240	320	400				
500 (CT 500:5)										300	400	500	
630 (CT 630:5)										378	504	630	
800 (CT 800:5)										480	640	800	
Phase protection	K-type		3 element										
	H-type		2 element										
Auxiliary contact		1NO+1NC											
Reset		Manual & Automatic											
Phase loss protection (Differential trip)		K-type only											
Applicable cable (mm <sup>2</sup> )	Main terminal	-			-			-			-		
	Aux. terminal	1-2.5											
Dimensions (mm)	Width × Height × Depth	180 × 159 × 187			180 × 185 × 185			180 × 205 × 185			245 × 223 × 197		
Weight (kg, K-type)		1.65			1.85			1.94			5.70		

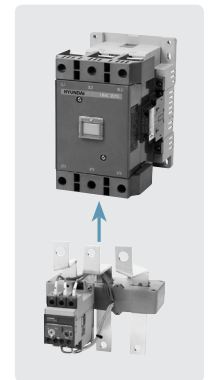
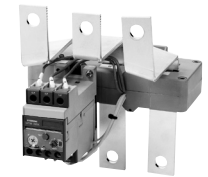
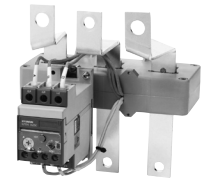
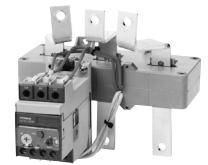

※ UTH makes trip within 2minutes on 150% overload at hot condition, so the protection class of UTH is 10A.

## ◆ Order information

UTH		800		K		A0800		S	
Code	Series	Code	Applicable contactor	Code	Element	Code	Setting current(A)	Code	Terminal accessory
UTH	UTH	150	UMC115-150	K	3	A0080	48-80	S	Safety cover
		265	UMC185-265	H	2	A0115	69-115		
		400	UMC300-500			A0130	78-130		
		800	UMC630-800			A0150	90-150		
						A0185	111-185		
						A0225	135-225		
						A0265	159-265		
						A0300	180-300		
						A0400	240-400		
						A0500	300-500		
						A0630	378-630		
						A0800	480-800		

## ◆ Standard order code and unit

Model	Code	Setting current (A)	Unit	Category	
UTH150	UTH150K A0080S	48-80	3	MC	CF
	UTH150K A0115S	69-115	3		
	UTH150K A0130S	78-130	3		
	UTH150K A0150S	90-150	3		
UTH265	UTH265K A0080S	48-80	3		
	UTH265K A0115S	69-115	3		
	UTH265K A0130S	78-130	3		
	UTH265K A0150S	90-150	3		
	UTH265K A0185S	111-185	3		
	UTH265K A0225S	135-225	3		
	UTH265K A0265S	159-265	3		
UTH400	UTH400K A0150S	90-150	3		
	UTH400K A0185S	111-185	3		
	UTH400K A0225S	135-225	3		
	UTH400K A0265S	159-265	3		
	UTH400K A0300S	180-300	3		
	UTH400K A0400S	240-400	3		
UTH800	UTH800K A0500S	300-500	1		
	UTH800K A0630S	378-630	1		
	UTH800K A0800S	480-800	1		

## Technical Information

**Main terminal (Line)**

**Model name**

**Current setting knob**

Three steps of the setting current can be adjusted by "+" or "-" driver.

**Setting current cover**

Unintended change of setting current or reset method can be prevented by setting current cover. Setting current cover can be sealed, so only authorized personnel can adjust the setting current and reset method.

**Main terminal (Load)**

Auxiliary contact

Main terminal

**Test button**

Test button is for test operation mainly. When the test button is pushed down, the NC contact opens; whereas, there is no change on NO contact. If the test button is pulled up, the status of the thermal overload relay becomes trip status; trip indicator comes up, NC contact opens, and NO contact closes. Test button can be also used for emergency stop.

**Trip indicator**

Trip indicator comes up in the event of trip, so the thermal overload relay status can be visually checked. The trip indicator should not be returned by force.

**Reset button**

**A position: Automatic reset**  
Thermal overload relay resets automatically around one minute after tripping.

**H position: Manual reset**  
This is factory setting value. Tripped thermal overload relay can be reset manually by pushing down the reset button. Manual reset shall be done at least one minute after tripping.

※ Excessive force on operation buttons can cause malfunction or damage.

◆ Phase loss protection

Differential tripping mechanism

- Differential tripping mechanism makes trip faster in the case of single phase loss than all three phase overloaded condition. As shown in the figure, when R phase is loss, the bimetal of R phase remains, so it fixes up the slide. At the same time, the other bimetals of S phase & T phase are bent, so they move the upper slide.
- The trip lever move to hit the trip mechanism according to the different moving ratio of lower slide and upper slide. Therefore, in the event of R phase loss, the tripping time is shorter than all three phase overloaded condition, and this is the same for S phase and T phase.

◆ Thermal overload relay selection

Short starting time motors

- For motors of normal starting time within a few seconds, the relays can be selected by the table of page 56.
- The full load current (FLC) of the motor must be within the setting range of the thermal overload relay.
- The starting time of high-inertia motor is an important factor at the selection of thermal overload relays.
- The tripping time of the motors, whose starting current is 6-7 times of the rated current, can be obtained from the UTH tripping curves, page 56. This time should be longer than around 125% of the motor starting time.

Long starting time motors

- If the starting time of the motor is longer than the tripping time of UTH, the current transformer type can be used.
- The current transformer type relays include the Non-Tripping features during the motor starting time.
- The rated current can be decreased by looping the primary cable several times on the transformer according to the following table.

Current configuration ratio according to loop turns (Example 130A)

Primary loop turns	Current range (A)	Current ratio
1	78-130	130/5
2	39-65	65/5
3	26-26.7	26.7/5
4	19.5-43.3	43.3/5
5	15.6-26	26/5
6	13-21.7	21.7/5
7	11.14-18.5	18.5/5
8	9.75-16.25	16.25/5

- The second rated current of current transformer is 5A, the overload relay is able to control the current between 3A and 5A.
- The corresponding setting value for the relay can be calculated by using the following formula.

$$\text{Setting current (A)} = \frac{\text{Rated current motor}}{\text{Current ratio}}$$

◆ Making and breaking capacities of auxiliary contacts

Voltage	AC15 <sup>1)</sup>		Voltage	DC13 <sup>2)</sup>	
	Aux. contact 95-96	Alarm contact 97-98		Aux. contact 95-96	Alarm contact 97-98
	Ie (A)	Ie (A)		Ie (A)	Ie (A)
110	2.0	1.2	24	1.0	1.0
220	1.5	1.0	110	0.4	0.4
500	1.0	0.5	220	0.15	0.15
660	0.5	0.3	440	0.07	0.07

※ 1) AC15: Making/breaking current = Ie x 10  
 2) DC13: Making/breaking current = Ie x 1.1

Tripping function

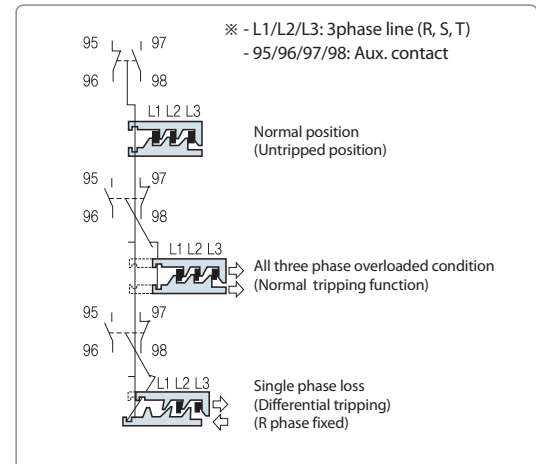

# Technical Information

## ◆ Tripping curve

- Tripping curve of 3 phase overload condition shows the average tripping time based on the cold starting at +20°C ambient temperature. Tripping time of hot starting is 20-40% of cold starting.
- Average tripping time of single phase overload is 40-60% of three phase overload.

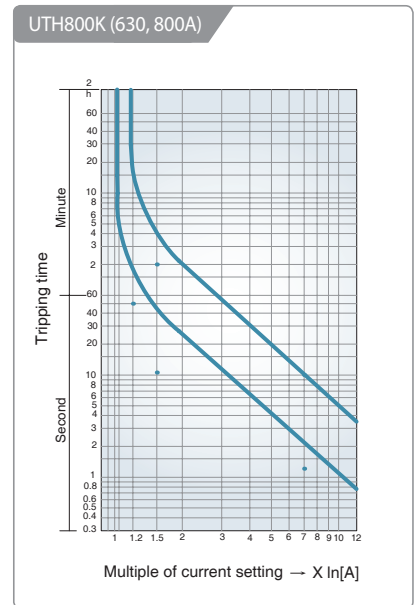
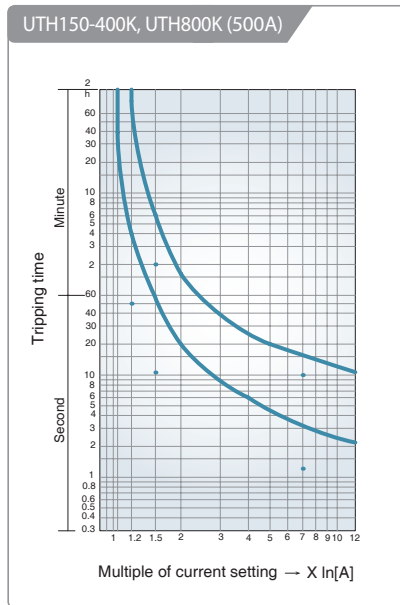
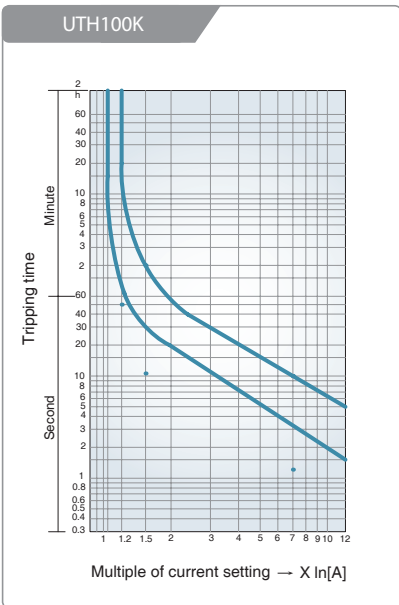
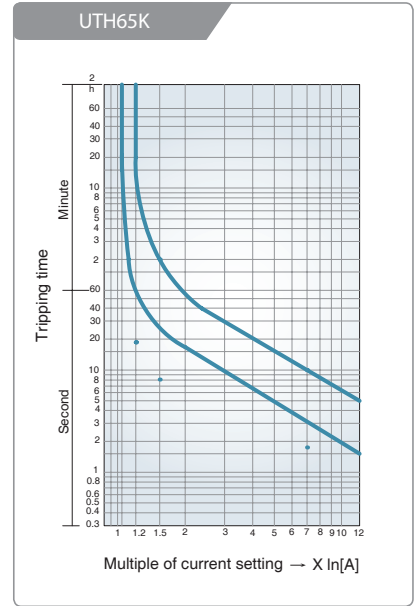
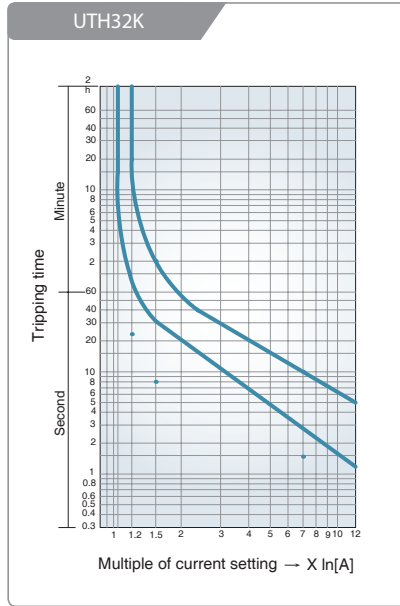
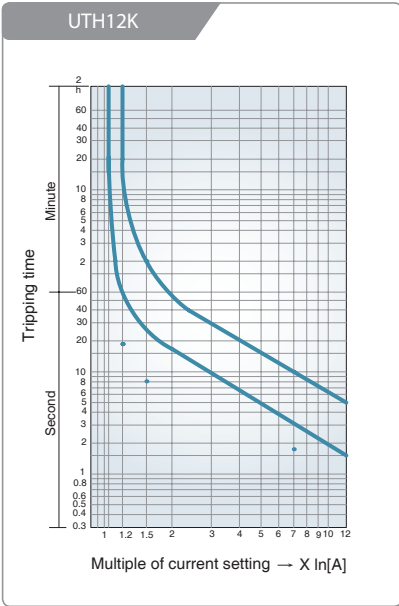



- Dimensions
- Installation
- Precautions



# Dimensions

## Contactor

(Unit: mm)

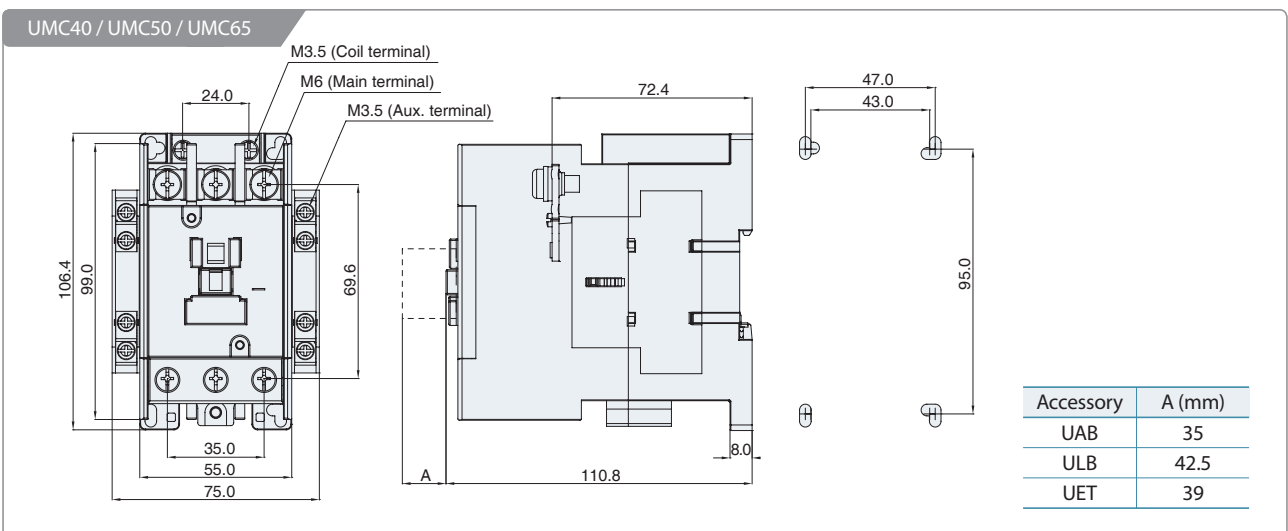
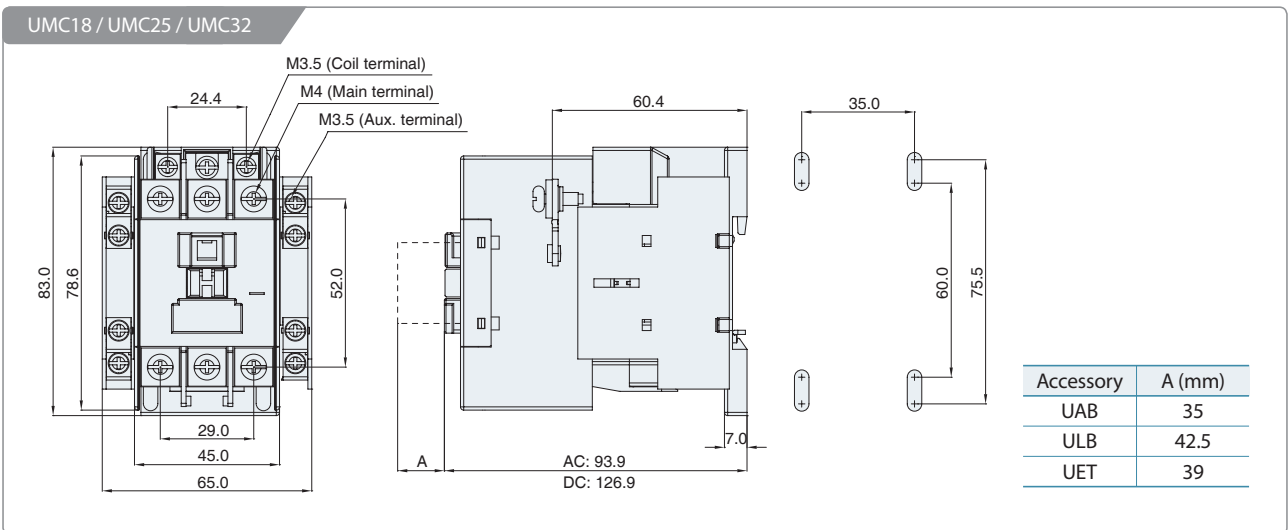
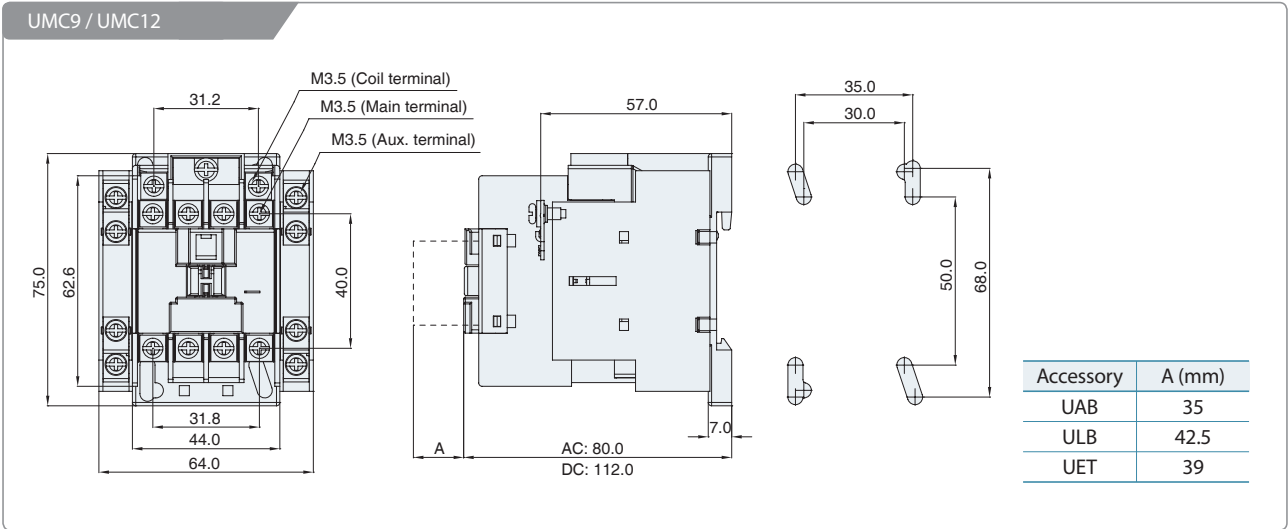

※ Dimensions may be revised without notice.

(Unit: mm)

UMC75 / UMC85 / UMC100

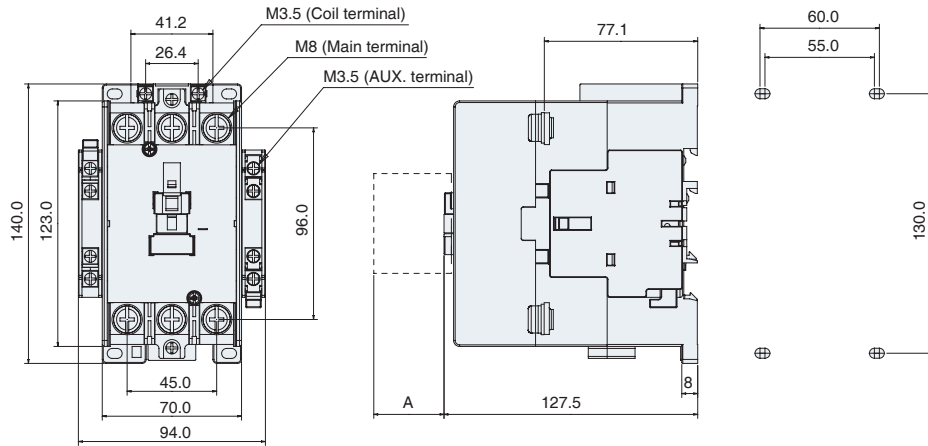

Accessory	A (mm)
UAB	35
ULB	42.5
UET	39

UMC115 / UMC130 / UMC150

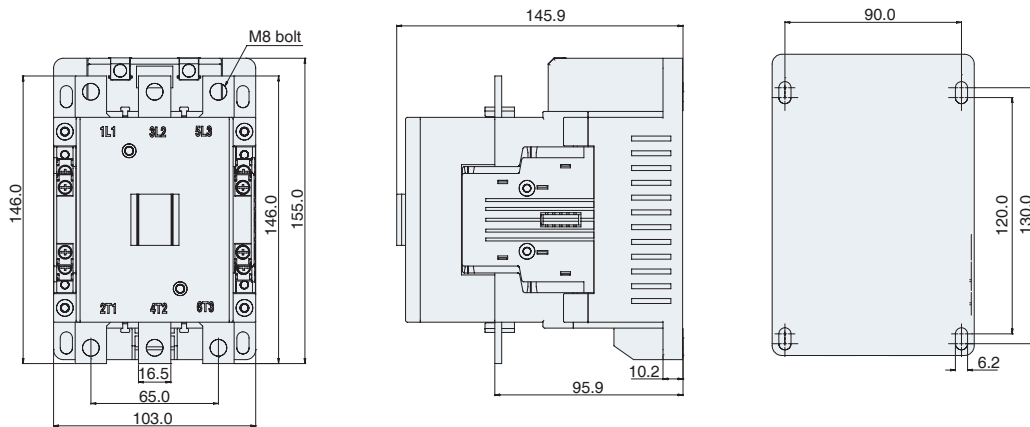

UMC185 / UMC225 / UMC265

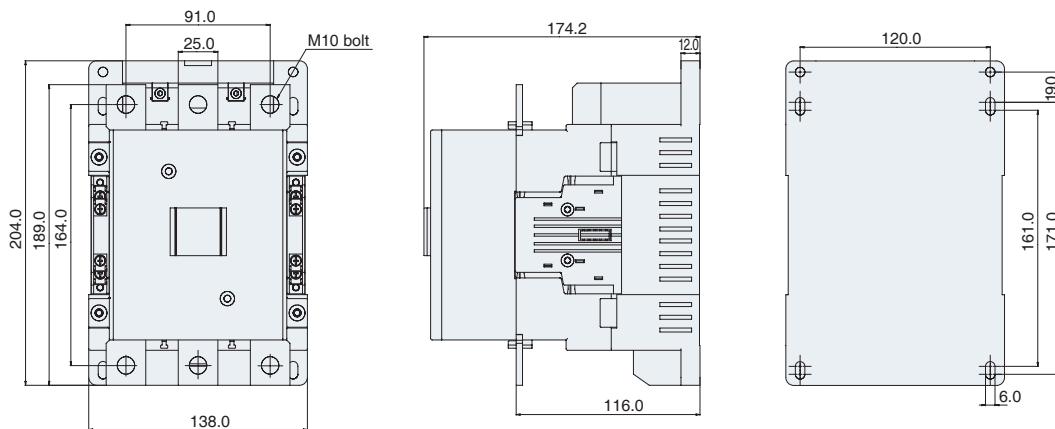

※ Dimensions may be revised without notice.

# Dimensions

## Contactor

(Unit: mm)

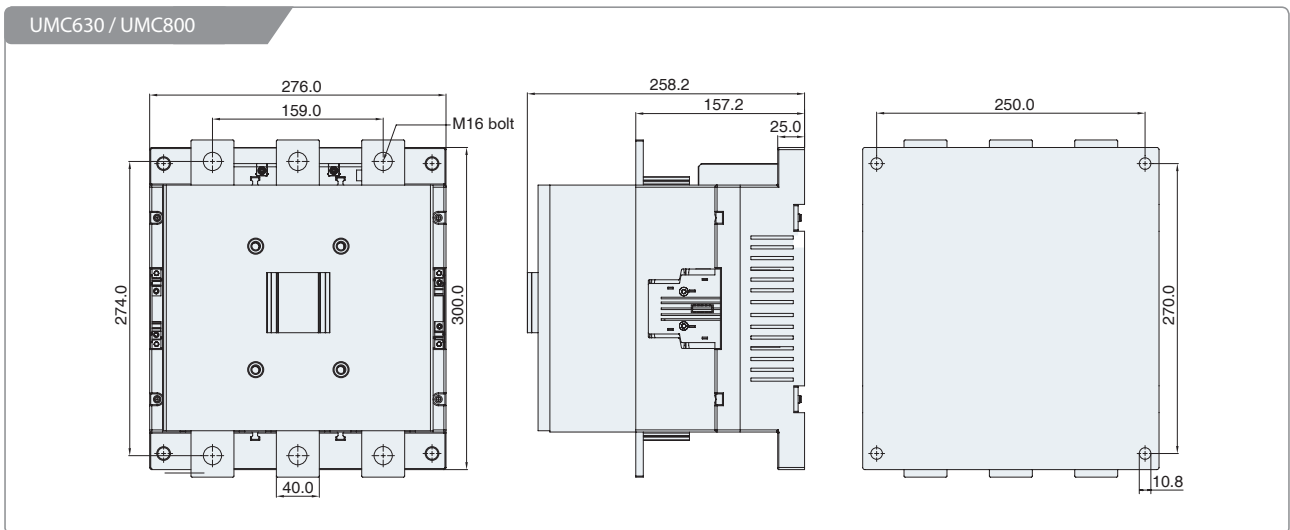
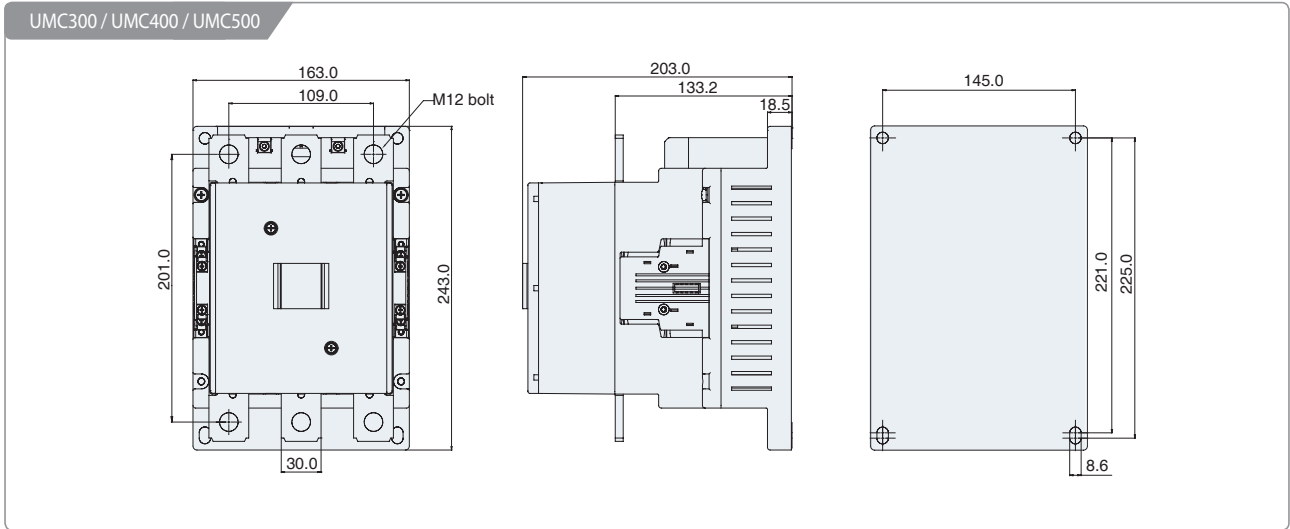

## Control relay

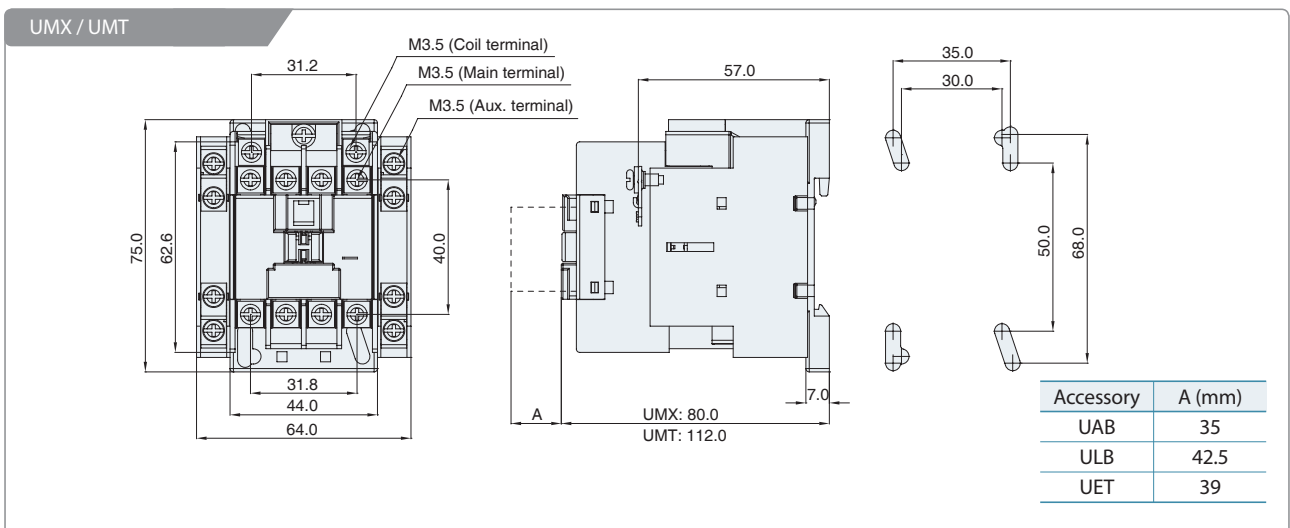

※ Dimensions may be revised without notice.

## Contactor with thermal overload relay

(Unit: mm)

UMC9 / UMC12 + UTH12

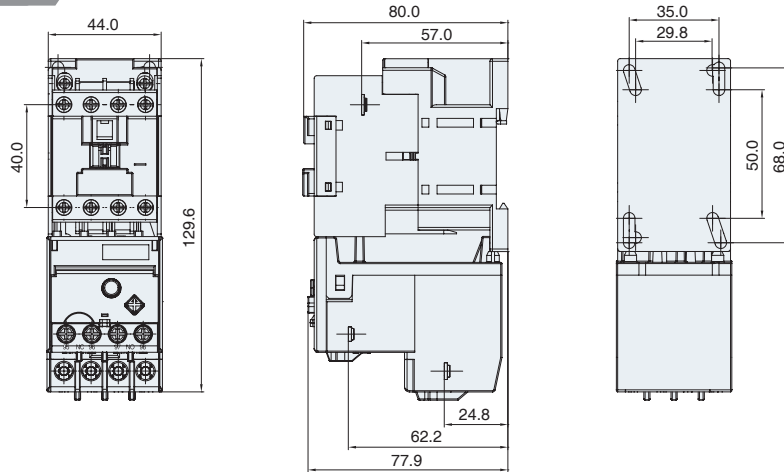

UMC18 / UMC25 / UMC32 + UTH32

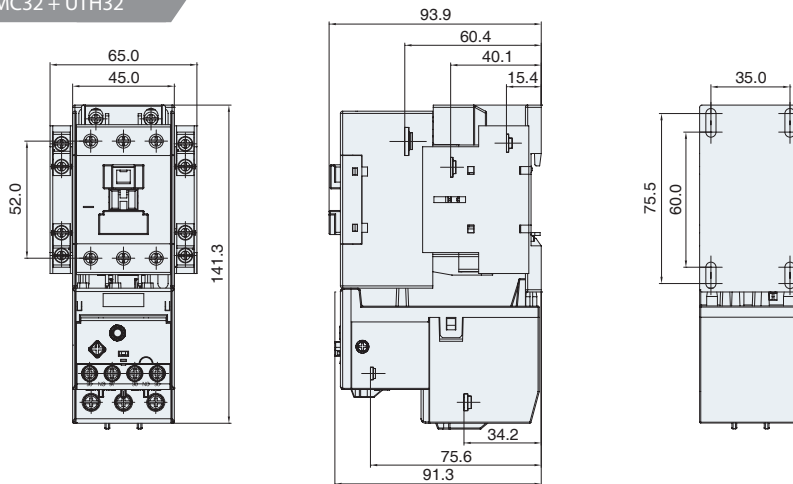

UMC40 / UMC50 / UMC65 + UTH65

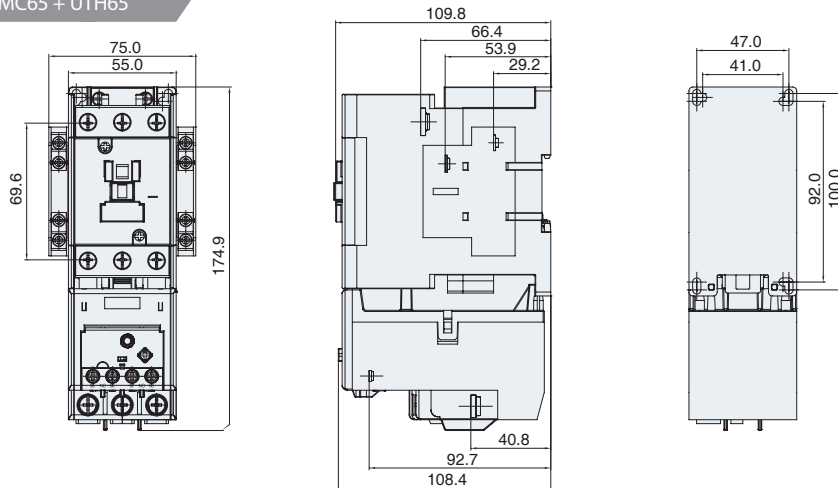

※ Dimensions may be revised without notice.

# Dimensions

## Contactor with thermal overload relay

(Unit: mm)

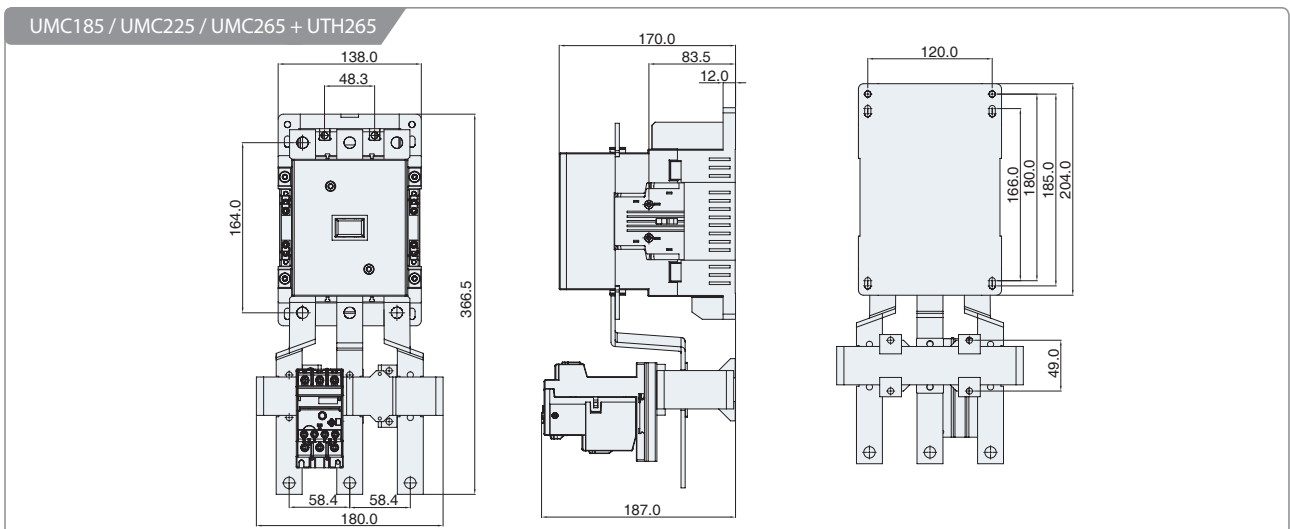
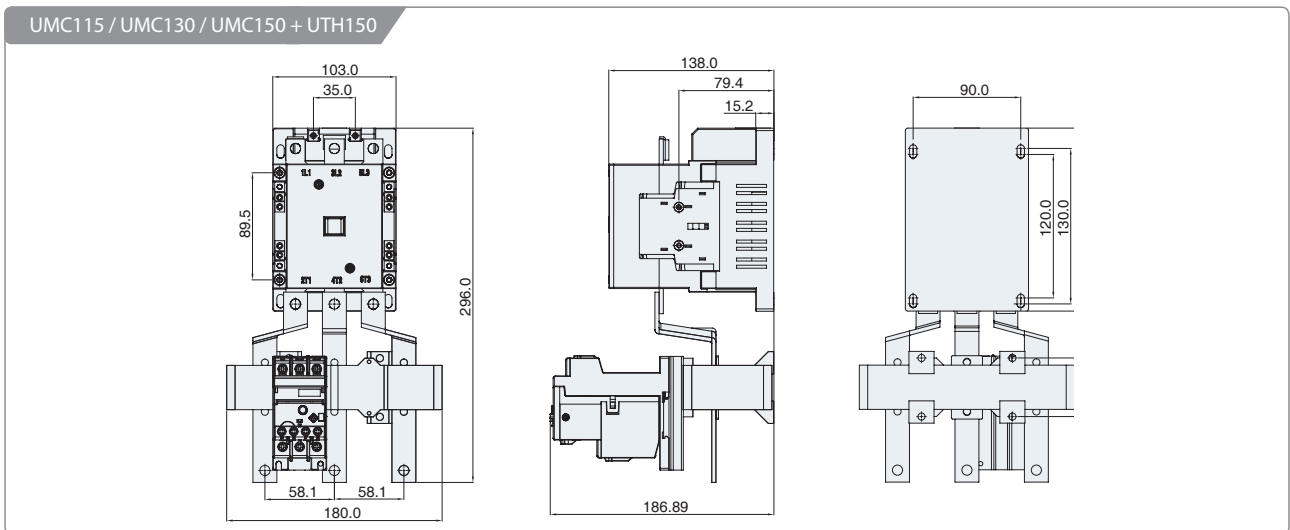
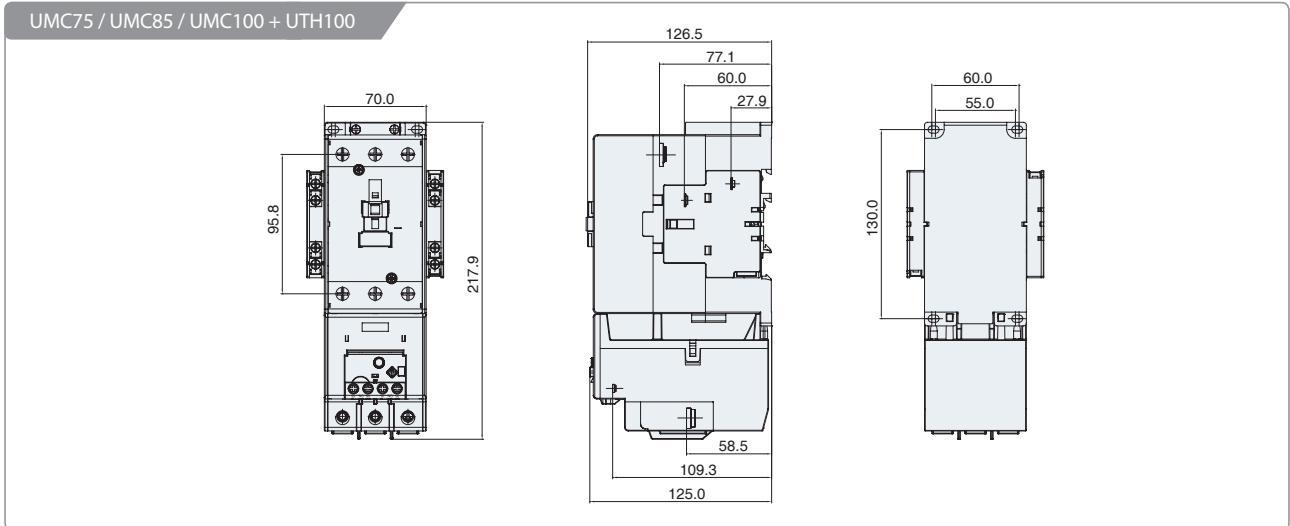

※ Dimensions may be revised without notice.

(Unit: mm)

UMC300 / UMC400 + UTH400

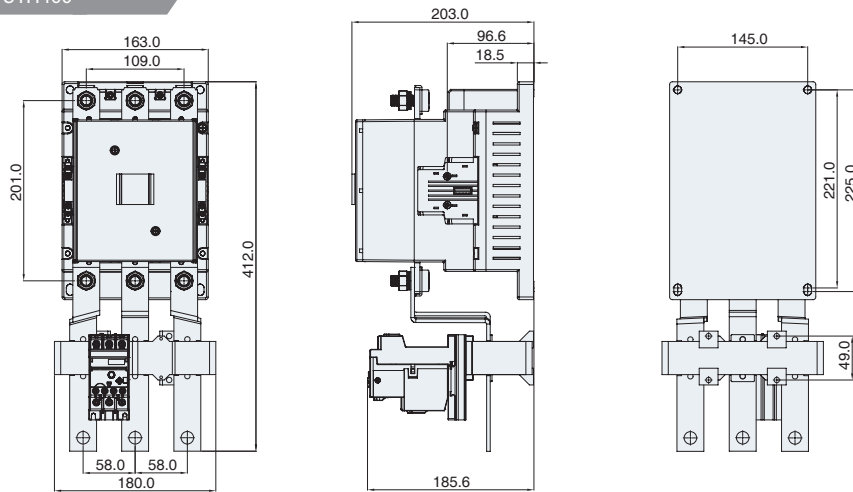

UMC500 + UTH800 (500A)

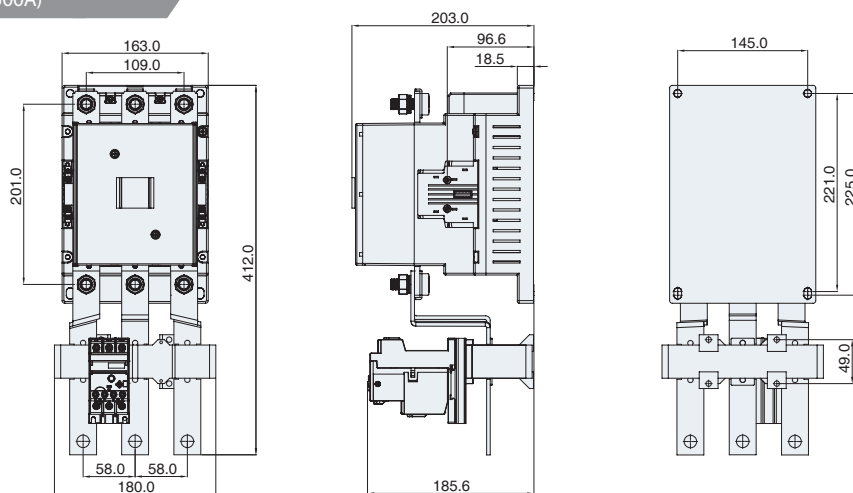

UMC630 / UMC800 + UTH800 (630, 800A)

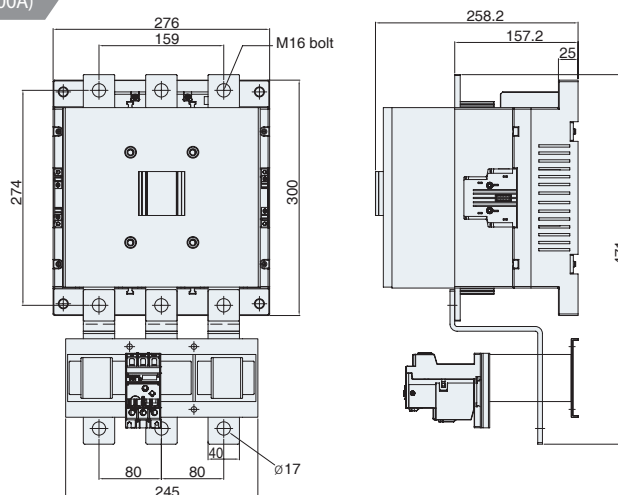

※ Dimensions may be revised without notice.

# Dimensions

## Thermal overload relay

(Unit: mm)

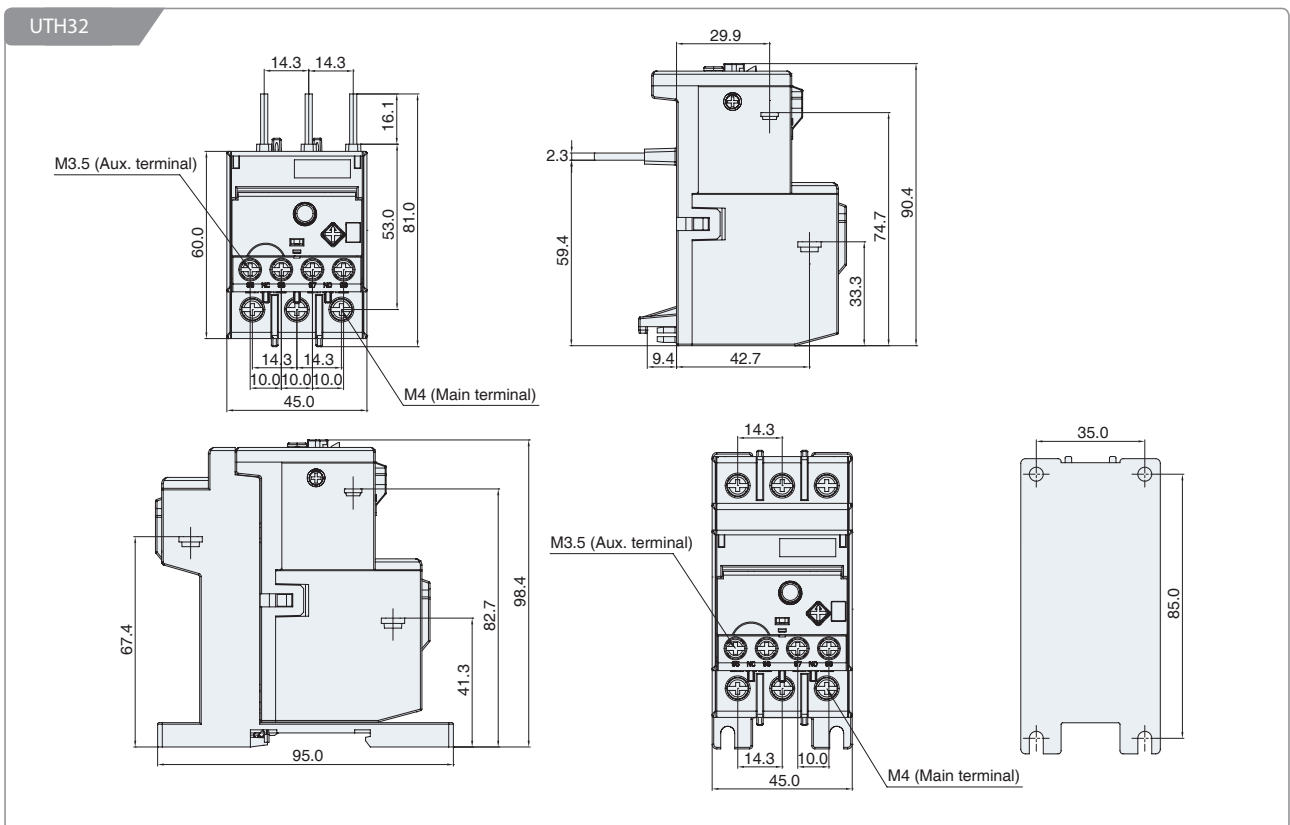
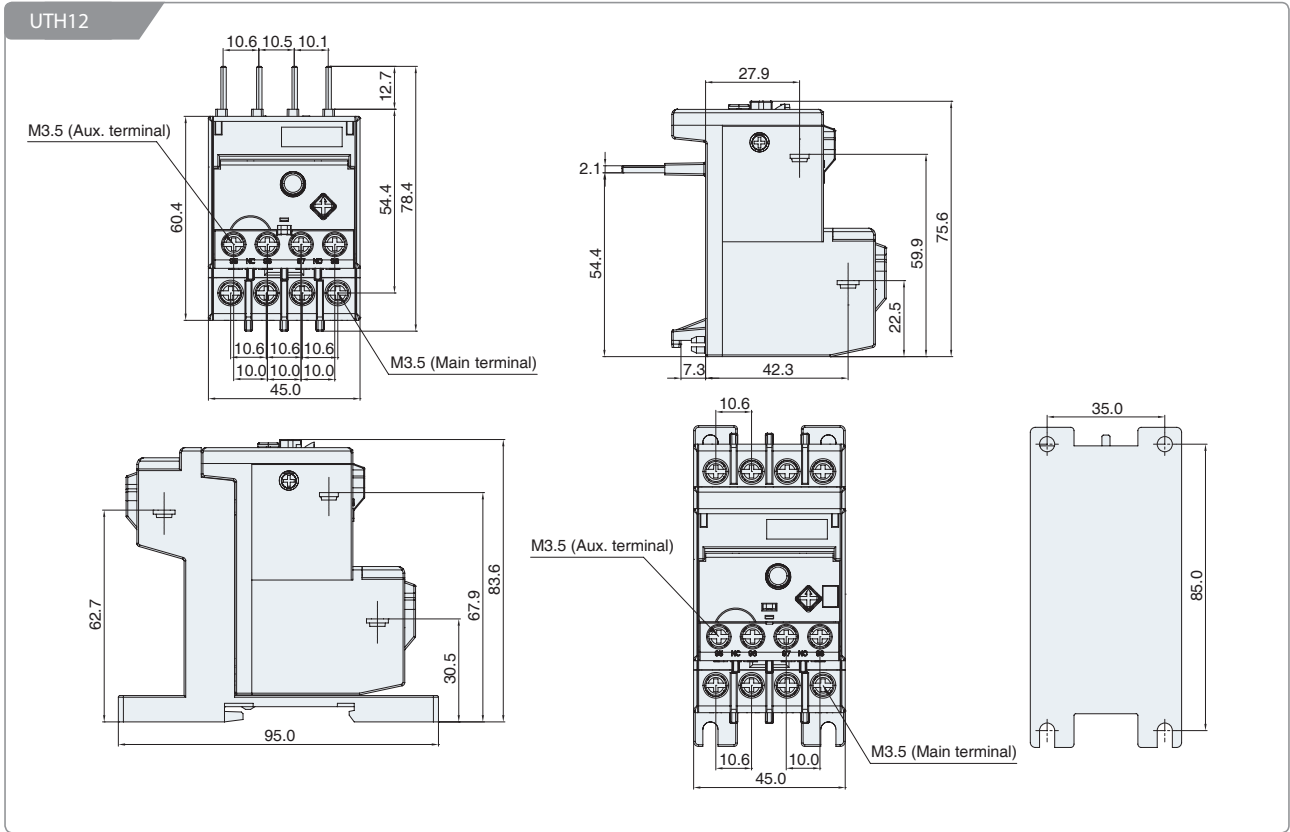

※ Dimensions may be revised without notice.



(Unit: mm)

UTH65

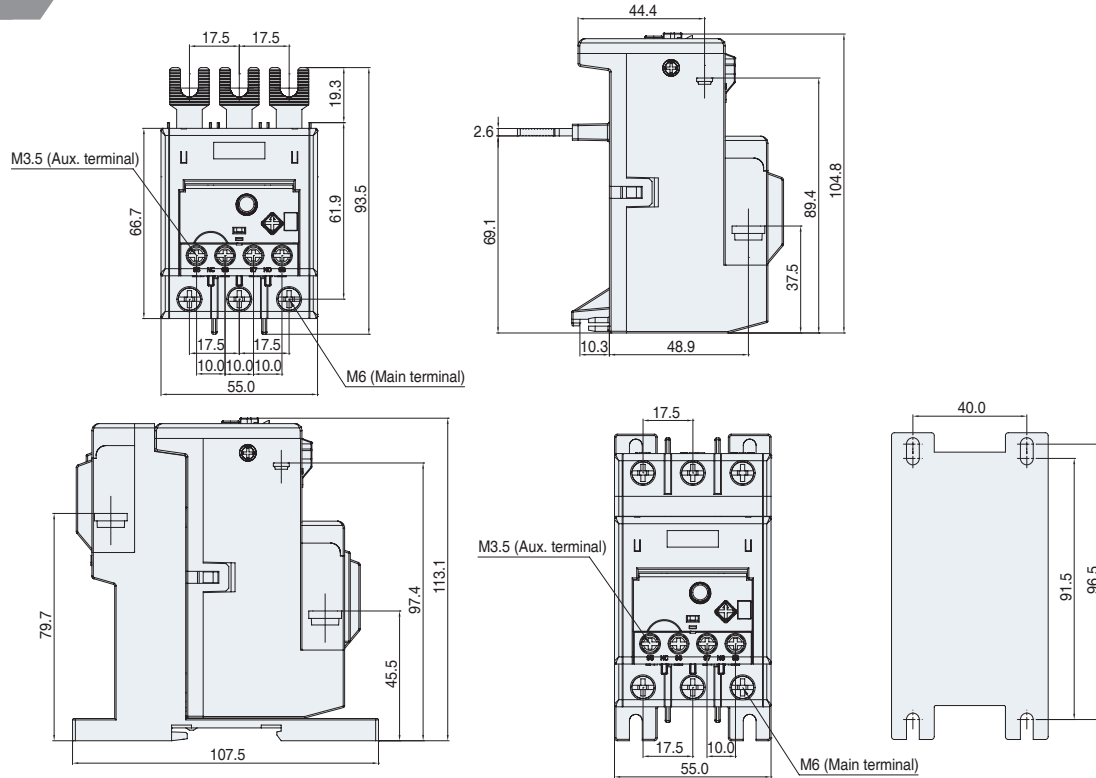

UTH100

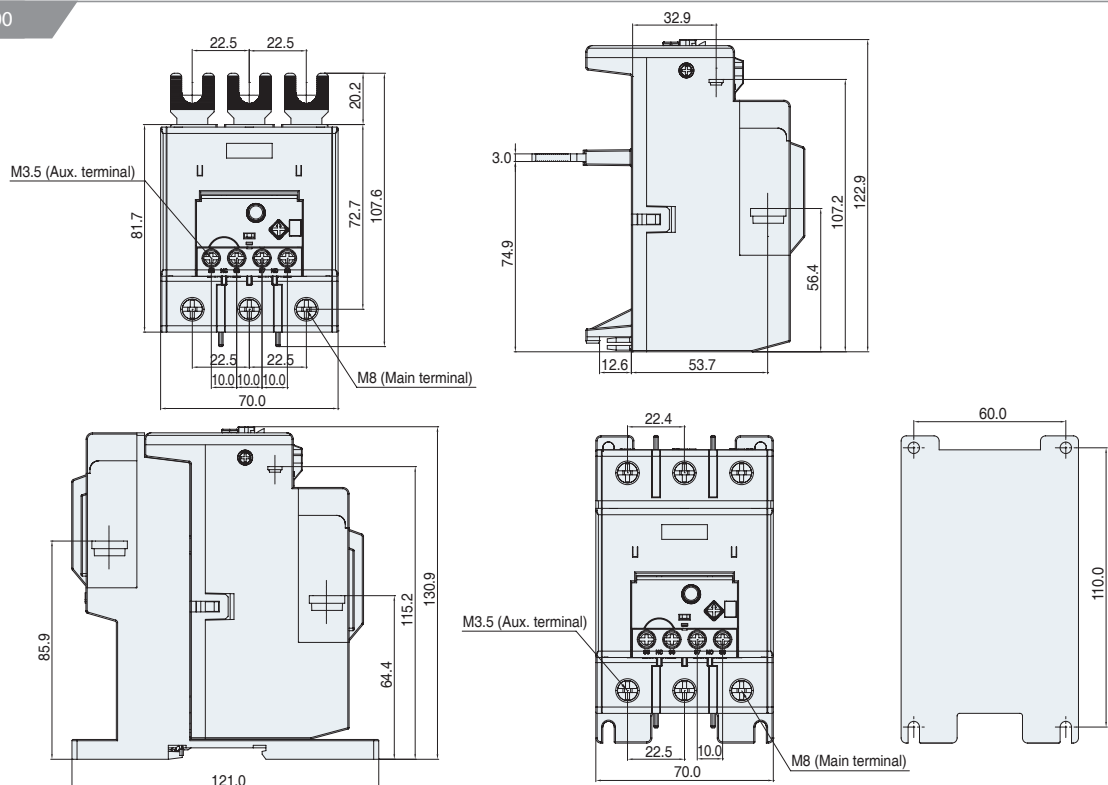

※ Dimensions may be revised without notice.

# Dimensions

## Thermal overload relay

(Unit: mm)

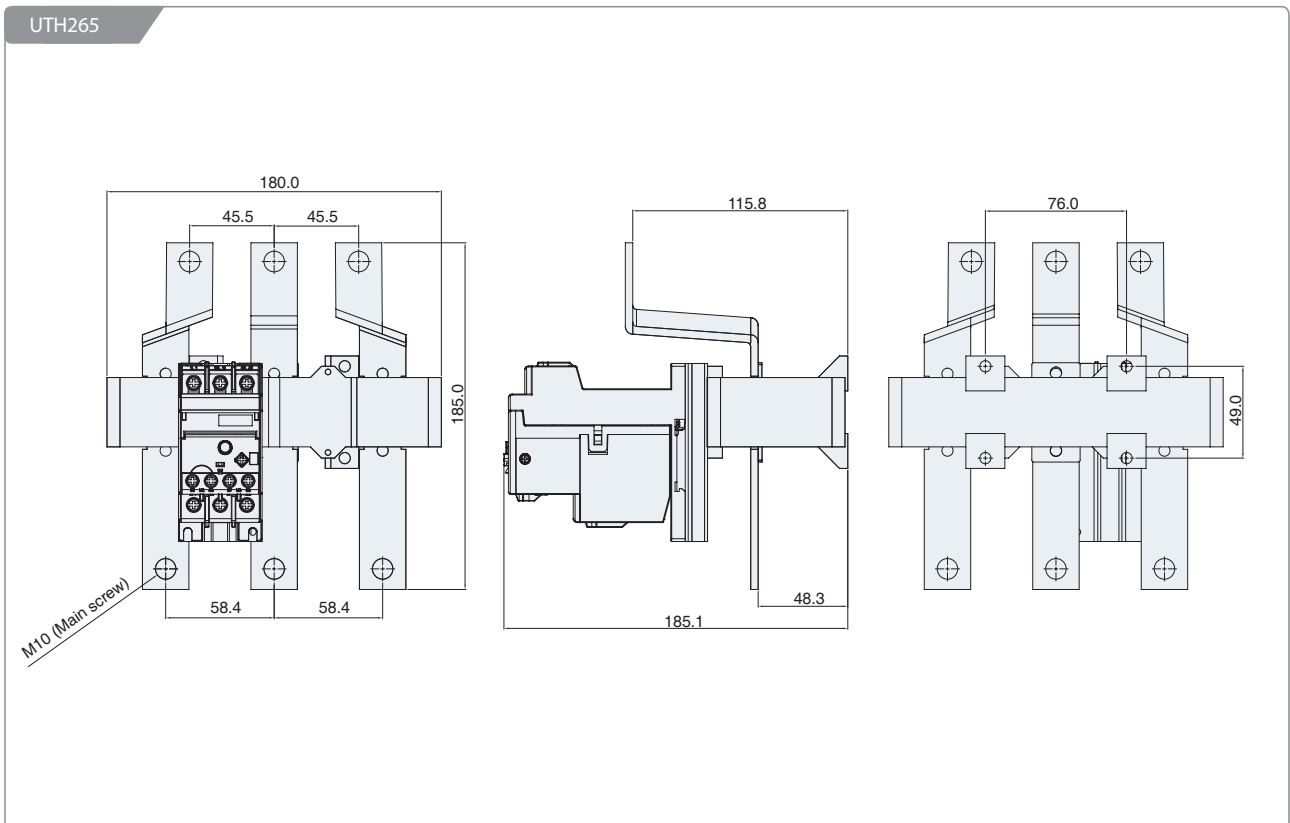
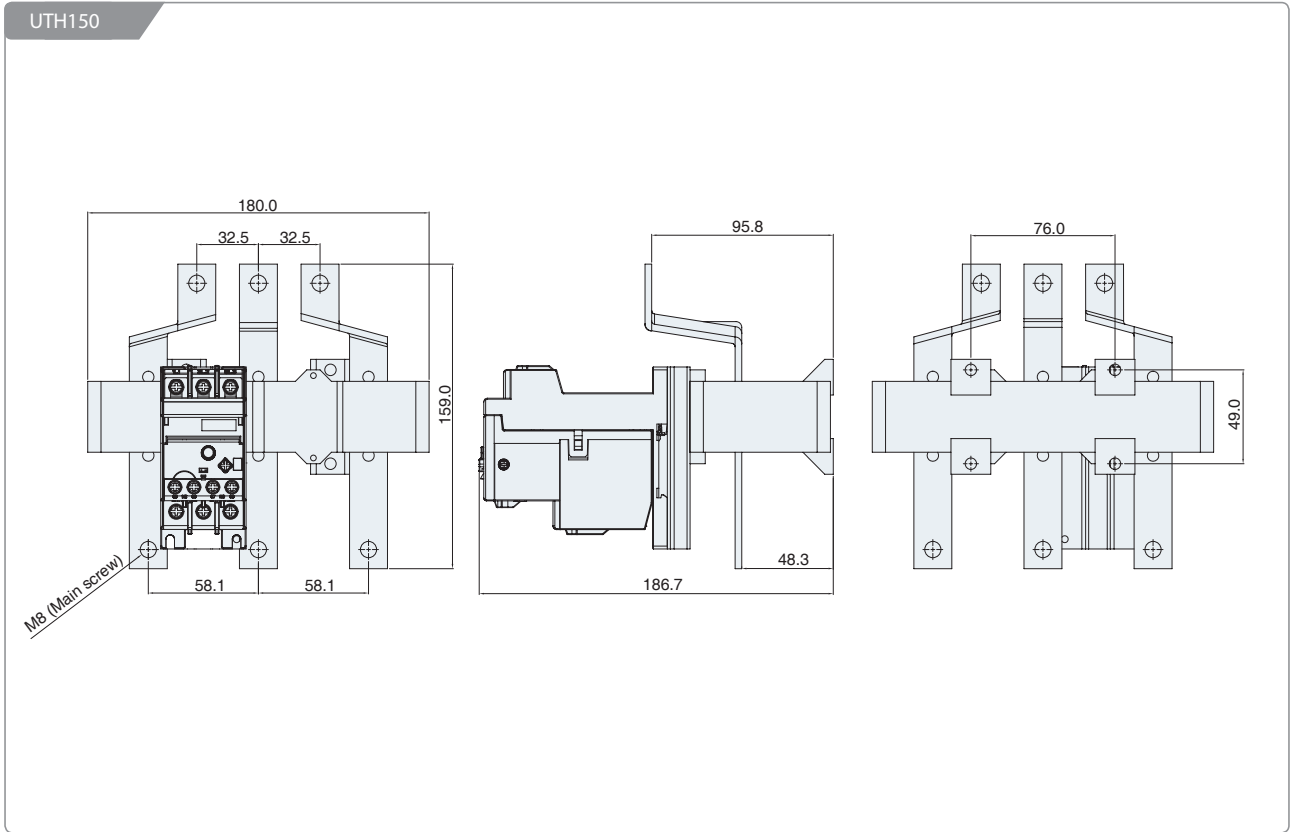

※ Dimensions may be revised without notice.

(Unit: mm)

UTH400 / UTH800 (500A)

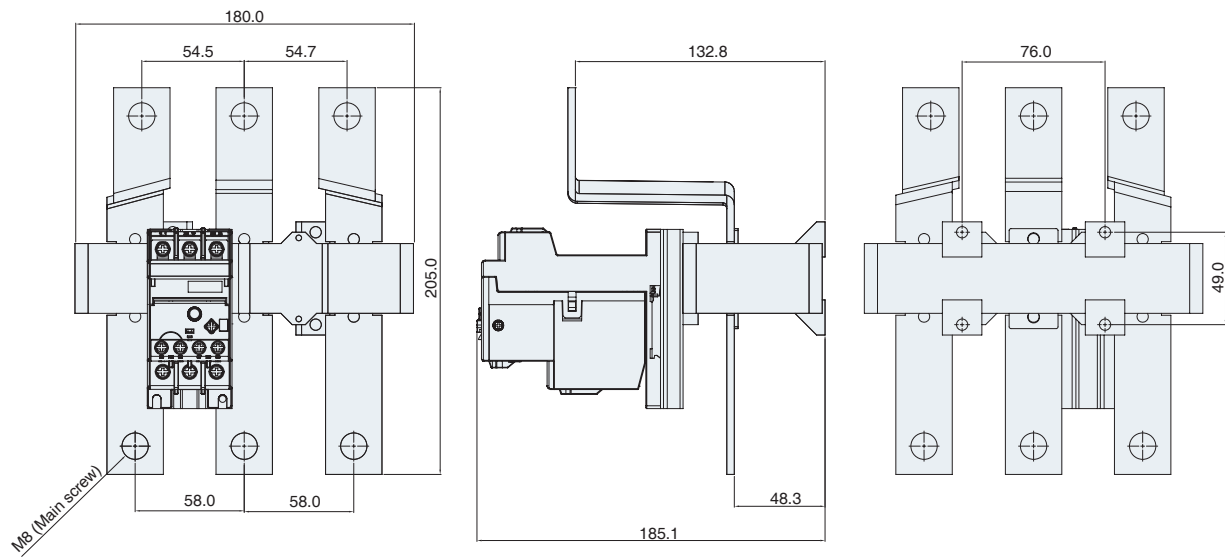

UTH800 (630, 800A)

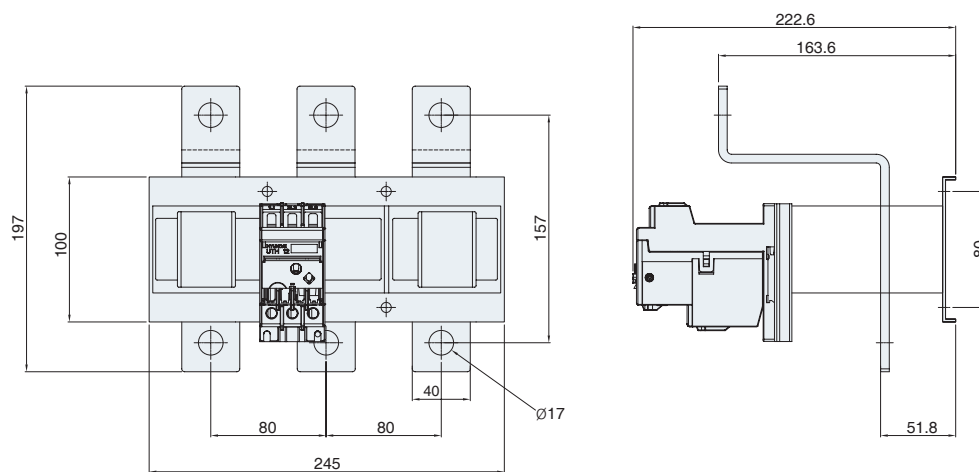

※ Dimensions may be revised without notice.

# Dimensions

## Contactors with mechanical interlock unit

(Unit: mm)

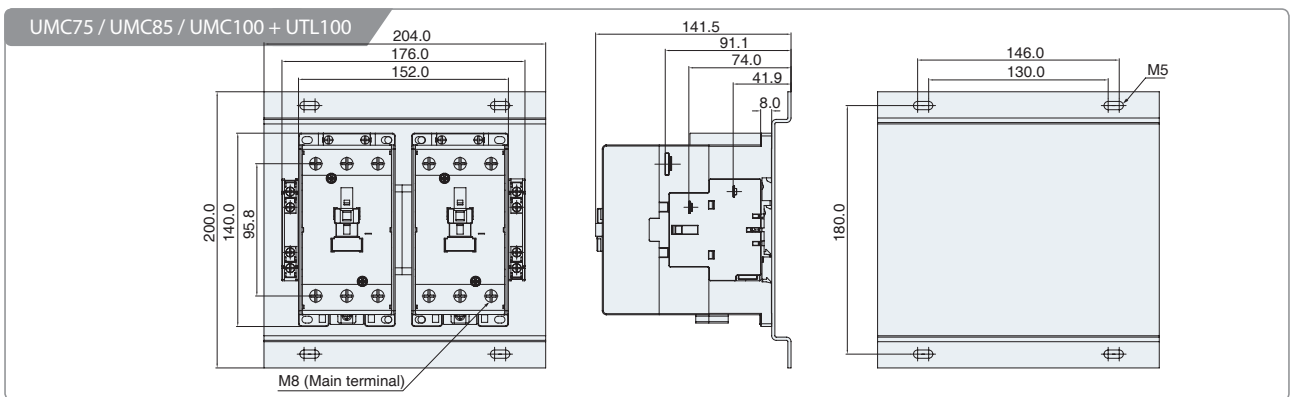
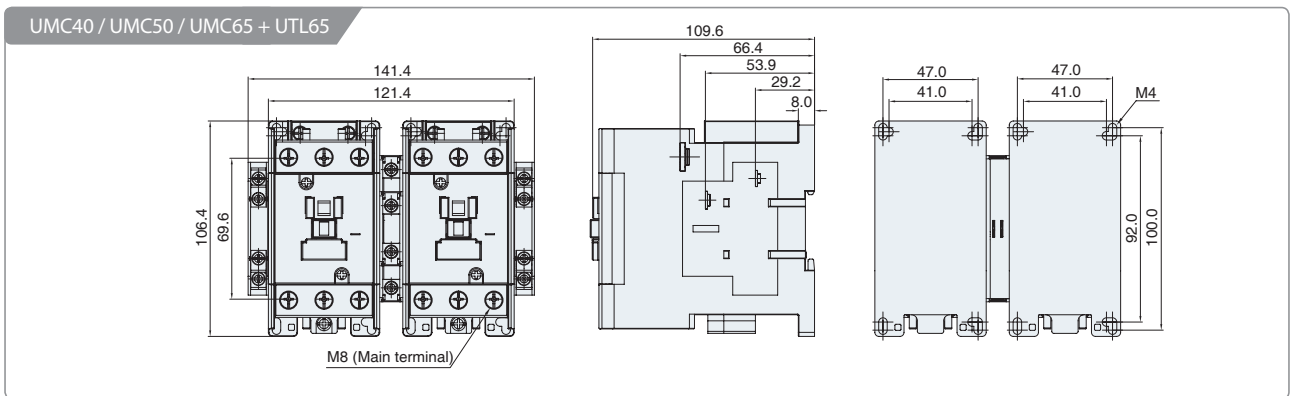
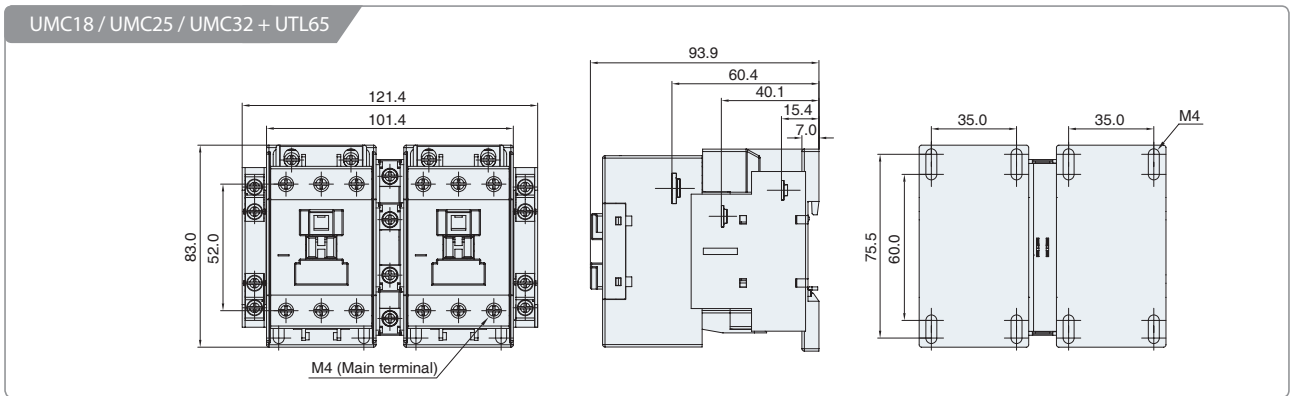
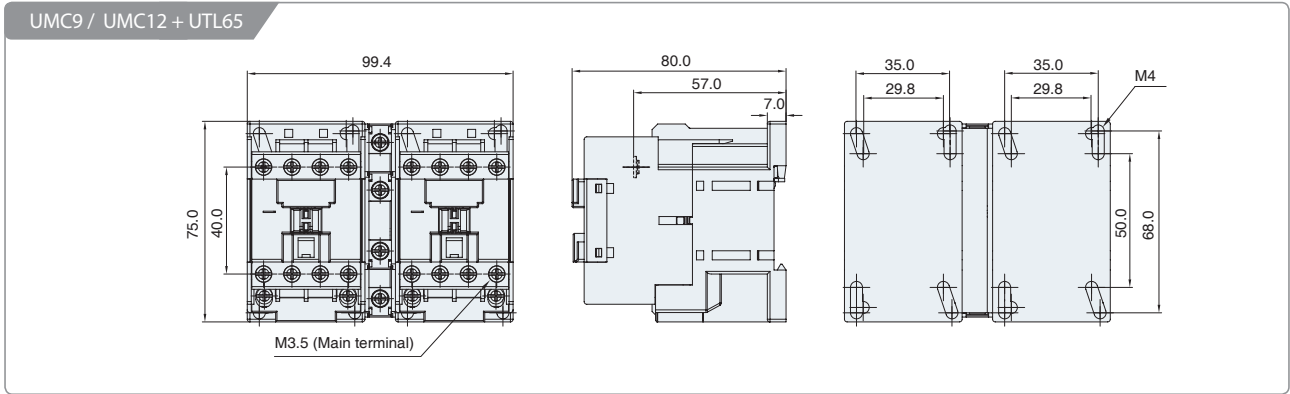

※ Dimensions may be revised without notice.

(Unit: mm)

UMC115 / UMC130 / UMC150 + UTL265

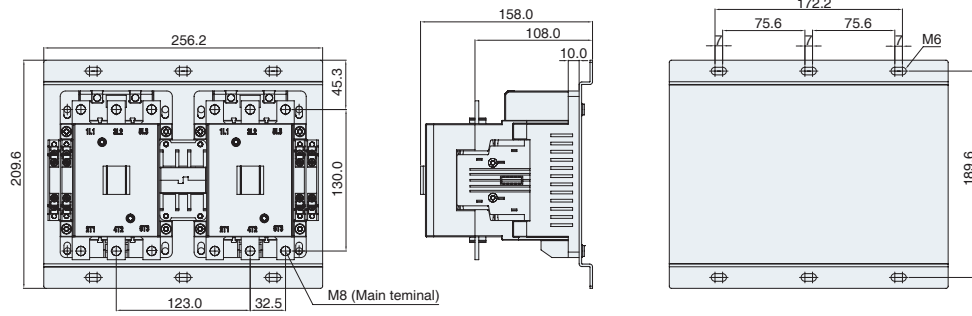

UMC185 / UMC225 / UMC265 + UTL265

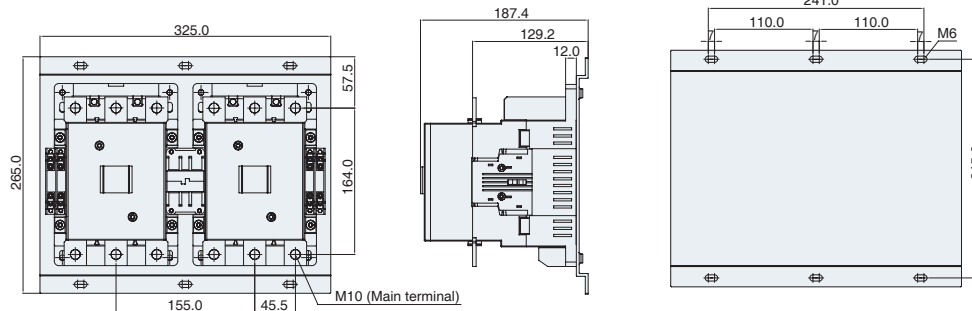

UMC300 / UMC400 / UMC500 + UTL400

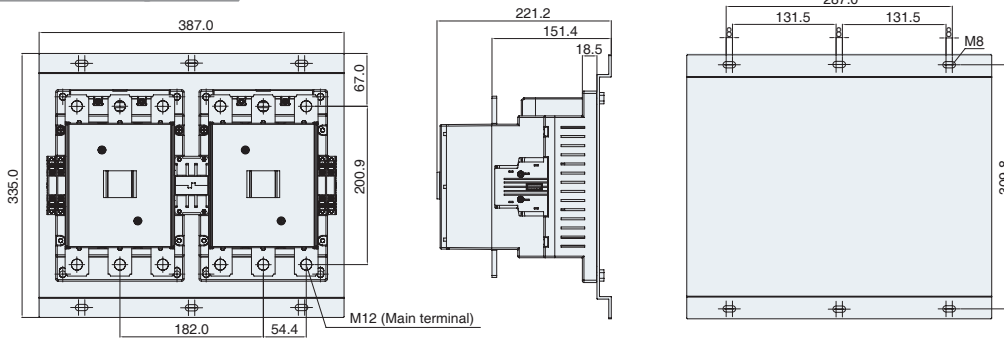

UMC630 / UMC800 + UTL400

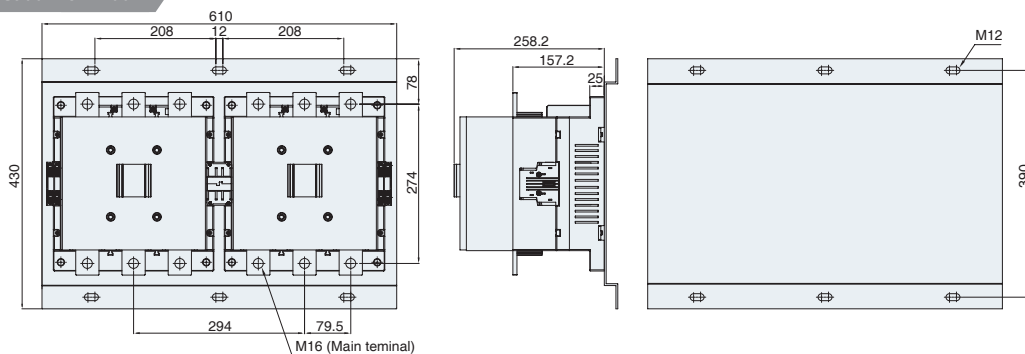

※ Dimensions may be revised without notice.

# Installation

◆ Standard operation conditions for normal performance

Ambient temperature	20°C (Standard), -25-40°C
Average temperature (24hours)	below 35°C
Storage temperature	-30-65°C, non freezing site
Relative humidity	40-85% RH
Altitude	below 2,000m
Vibration-proof	10-55Hz, 2g
Impact-proof	5g

- ◆ Please install the contactor in the place free from moisture and vibration.
- ◆ It is recommended to install the contactor in a vertical plane, but +30° slant is acceptable as standard installation.
- ◆ Lateral or horizontal installation could decrease the mechanical lifetime and electrical performance of contactor compared with standard installation.

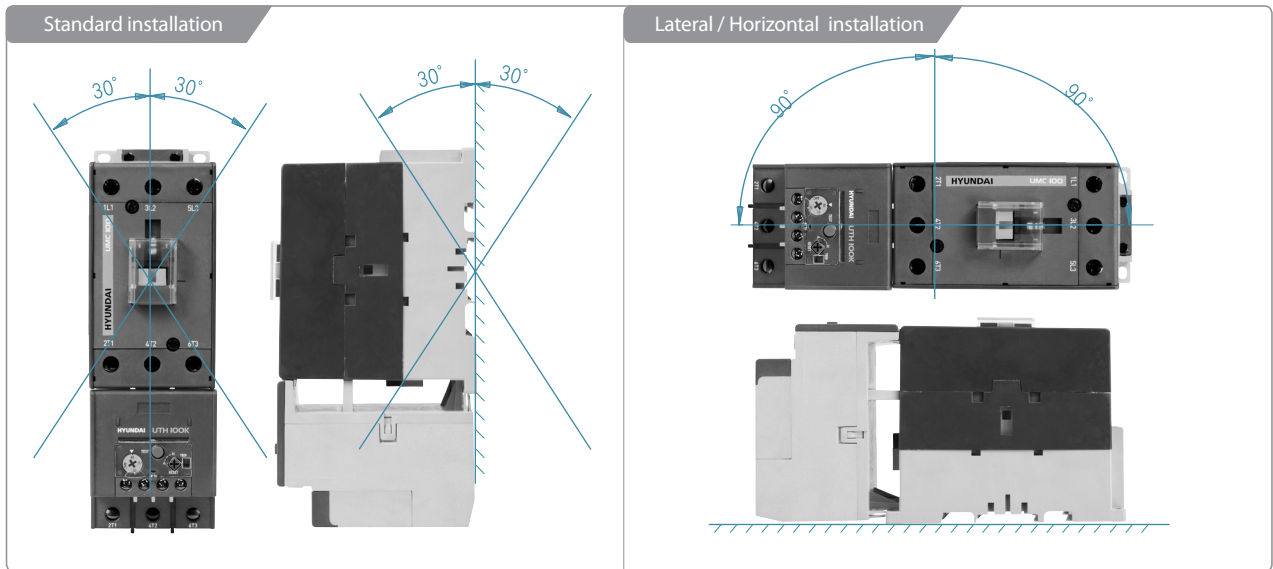

◆ Minimum insulation distance

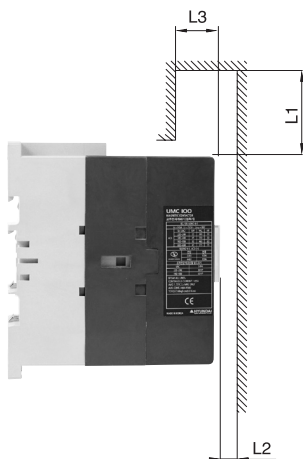

(Unit: mm)

Contactor Distance	UMC75-100	UMC115-150	UMC185-265	UMC300-500	UMC630-800
L1	30	30	80	80	90
L2	5	15	15	15	20
L3	6	11	32	32	40

# Precautions

## ◆ Safety precautions



- All procedures must be conducted only by qualified persons. Otherwise, electrical shock, personnel injury, or a fire could occur.
- The product shall not be stored or operated in abnormal environment, such as, but not limited to, high temperature, high humidity, over vibration, and corrosive gas.
- All care must be taken to prevent dust, moisture, and foreign objects from entering the product.

## ◆ Transportation and storage

NOTICE

- Do not open the package.
- Do not drop or apply shock.
- Do not store in high temperature, high humidity, or corrosive gas.

## ◆ Check point before operation



- Do not operate before setting and adjustment.

## ◆ Precautions for installation, operation, and maintenance



- All procedures must be conducted only by qualified persons. Otherwise, electrical shock, personnel injury, or a fire could occur.
- Rated current, rated voltage, load capacity, frequency, but not limited to, of the product must meet the load.
- The product, bolt tightness, assembled status, and operating condition shall be checked visually and electrically from time to time. If any damage occurs, the product or parts must be replaced immediately.
- Power must be OFF before wiring work.
- All wirings, especially for main terminal and coil terminal, shall be tightened by proper torque in correct manner.
- Cable and terminal must be suitable for the product and the load.
- Lubrication is prohibited on the product, parts, and wirings.
- Any modification, deforming, or machining of the product or parts is prohibited.
- The function of product and part shall be checked occasionally.



[www.hyundai-elec.com](http://www.hyundai-elec.com)



## ELECTRO ELECTRIC SYSTEMS

<b>Head Office</b>	1, Jeonha-dong, Dong-gu, Ulsan, Korea Tel: 82-52-202-8101-8 Fax: 82-52-202-8100
<b>Seoul (Sales &amp; Marketing)</b>	140-2, Gye-dong, Jongno-gu, Seoul, Korea Tel: 82-2-746-8519, 7510 Fax: 82-2-746-7647
<b>Orlando</b>	4700 Millenia Blvd., Suite 370, Orlando, Florida 32839, U.S.A. Tel: 1-407-249-7350 Fax: 1-407-275-4940
<b>New Jersey</b>	300 Sylvan Avenue, Englewood Cliffs, NJ, 07632, U.S.A. Tel: 1-201-816-0286, 8028 Fax: 1-201-816-4083
<b>Chicago</b>	1090 Fargo Avenue Elk Grove Village, IL60007, U.S.A. Tel: 1-847-228-8845 Fax: 1-847-437-3574
<b>London</b>	2nd Floor, The Triangle, 5-17 Hammersmith Grove, London, W6 0LG, UK Tel: 44-20-8741-0501 Fax: 44-20-8741-5620
<b>Tokyo</b>	8th Fl., Yurakucho Denki Bldg.1-7-1, Yuraku-cho, Chiyoda-gu, Tokyo, 100-0006, Japan Tel: 81-3-3212-2076, 3215-7159 Fax: 81-3-3211-2093
<b>Osaka</b>	I-Room 5th Fl. Nagahori-Plaza Bldg. 2-4-8, Minami Senba, Chuo-Ku, Osaka, 542-0081, Japan Tel: 81-6-6261-5766, 5767 Fax: 81-6-6261-5818
<b>Riyadh</b>	2nd Floor, the Plaza, P.O.Box 21840 Riyadh 11485, Saudi Arabia Tel: 966-1-462-2331 Fax: 966-1-464-4696
<b>Dubai</b>	205, Building 4, Emaar Square, Sheikh Zayed Road, Pobox 252458, Dubai, UAE Tel: 971-4-425-7995 Fax: 971-4-425-7996
<b>Kuwait</b>	Floor 15, Al Sour Tower, Al Sour Street, Al-Qiblah, Kuwait Tel: 965-2291-5354 Fax: 965-2291-5355
<b>Moscow</b>	World Trade Center, Ent. 3, #1902, Krasnopresnenskaya Nab.12, Moscow, 123610, Russia Tel: 7-495-258-1381 Fax: 7-495-258-1382
<b>Madrid</b>	Paseo De La Castellana 216, Planta 0, 28046 Madrid, Spain Tel: 34-91-732-0454 Fax: 34-91-733-2389
<b>Sofia</b>	1271, Sofia 41, Rojen Blvd., Bulgaria Tel: 359-2-803-3200, 3220 Fax: 359-2-803-3203
<b>Montgomery</b>	600 South Court Street, Suite 316 Montgomery, AL36104, U.S.A. Tel: 1-334-230-9921 Fax: 1-334-240-6869
<b>Yangzhong</b>	No.9 Xiandai Road, Xinba Scientific and Technologic Zone, Yangzhong, Jiangsu, P.R.C. Zip: 212212, China Tel: 86-511-8842-0666, 0212 Fax: 86-511-8842-0668, 0231