

Data Sheet

Botonera gris de 1 elemento	UCB1-1-K
Norma de referencia	IEC60947-5-1:2009 GB14048.5-2008
Material	ABS
Color	Base negra y tapa gris
Temperatura de funcionamiento	ABS: -40° C ~ +80° C PC: -40° C ~ +120° C
Resistencia al fuego	ABS: V0 PC: V2
Grado de protección IP	IP65
Cubierta	Opaca, fijación con tornillo
Huecos 22mm	1

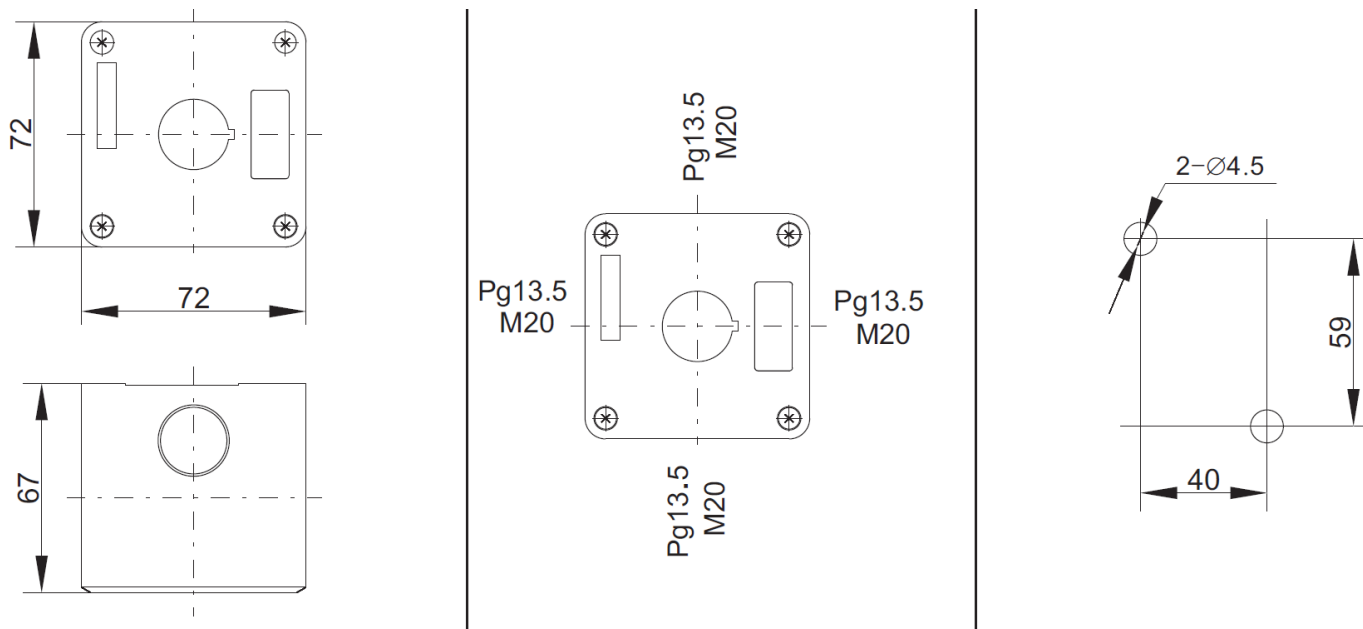

Dimensiones



Data Sheet

Botonera naranja de 1 elemento	UCB1-1-KY
Norma de referencia	IEC60947-5-1:2009 GB14048.5-2008
Material	ABS
Color	Base negra y tapa naranja
Temperatura de funcionamiento	ABS: -40° C ~ +80° C PC: -40° C ~ +120° C
Resistencia al fuego	ABS: V0 PC: V2
Grado de protección IP	IP65
Cubierta	Opaca, fijación con tornillo
Huecos 22mm	1

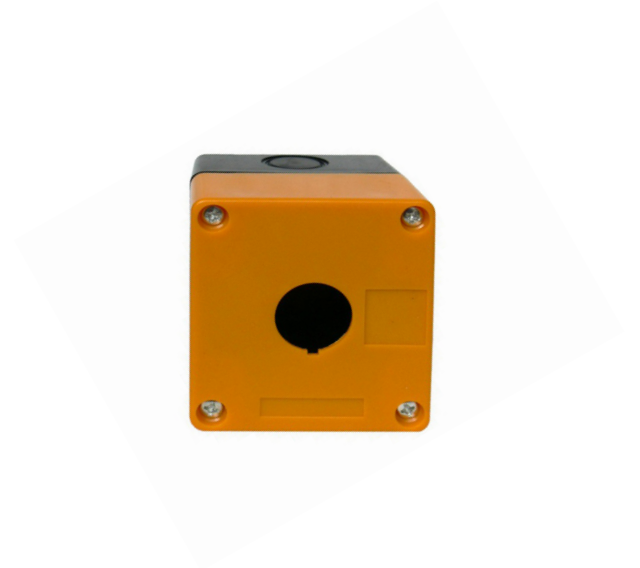

Dimensiones

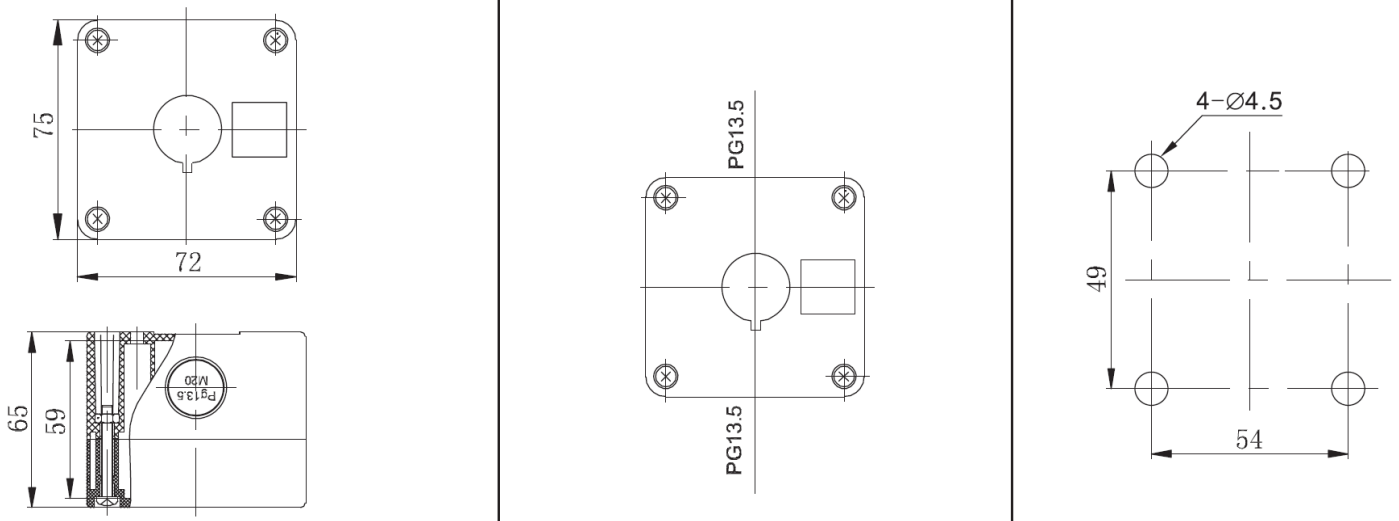

Data Sheet

Botonera gris de 2 elemento

UCB1-2-K

Norma de referencia	IEC60947-5-1:2009 GB14048.5-2008
Material	ABS
Color	Base negra y tapa gris
Temperatura de funcionamiento	ABS: -40° C ~ +80° C PC: -40° C ~ +120° C
Resistencia al fuego	ABS: V0 PC: V2
Grado de protección IP	IP65
Cubierta	Opaca, fijación con tornillo
Huecos 22mm	2



Dimensiones

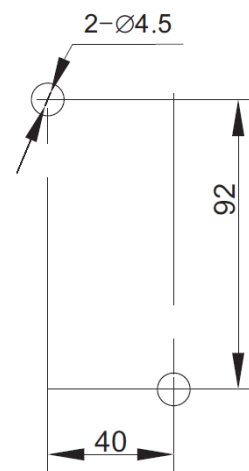
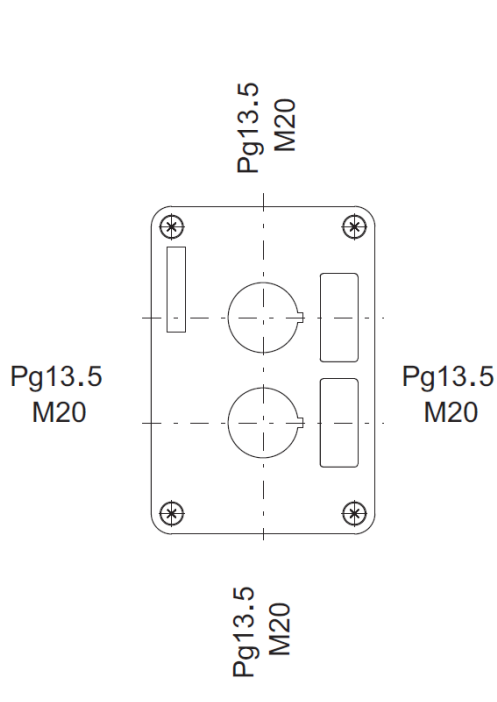
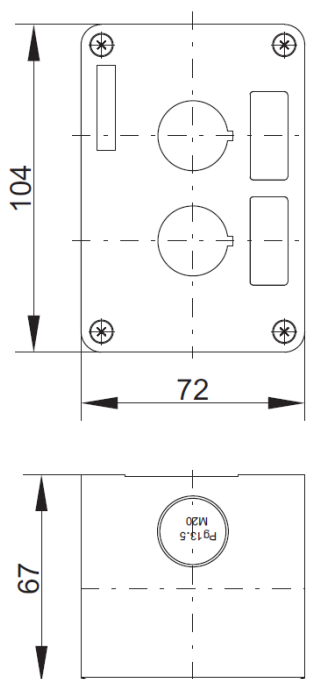

Data Sheet

Botonera naranja de 2 elementos

UCB1-2-KY

Norma de referencia	IEC60947-5-1:2009 GB14048.5-2008
Material	ABS
Color	Base negra y tapa naranja
Temperatura de funcionamiento	ABS: -40° C ~ +80° C PC: -40° C ~ +120° C
Resistencia al fuego	ABS: V0 PC: V2
Grado de protección IP	IP65
Cubierta	Opaca, fijación con tornillo
Huecos 22mm	2

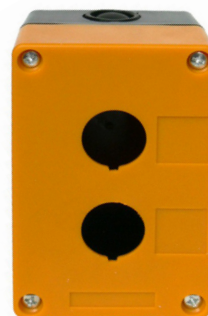

Dimensiones

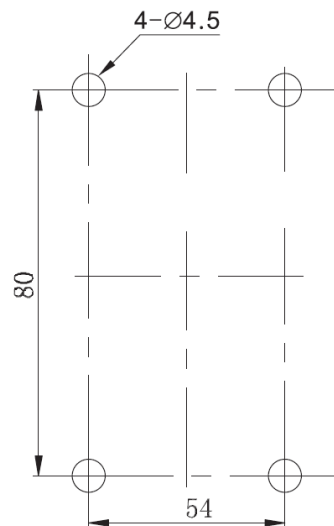
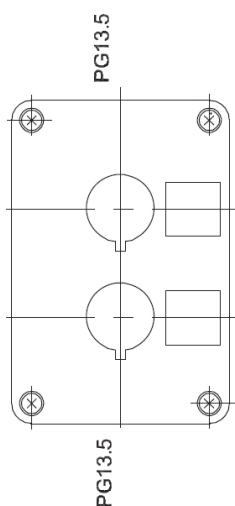
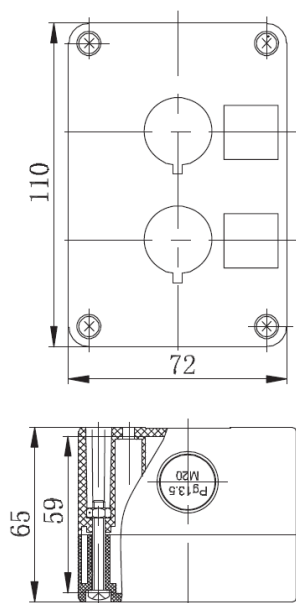

Data Sheet

Botonera gris de 3 elementos

UCB1-3-K

Norma de referencia	IEC60947-5-1:2009 GB14048.5-2008
Material	ABS
Color	Base negra y tapa gris
Temperatura de funcionamiento	ABS: -40° C ~ +80° C PC: -40° C ~ +120° C
Resistencia al fuego	ABS: V0 PC: V2
Grado de protección IP	IP65
Cubierta	Opaca, fijación con tornillo
Huecos 22mm	3



Dimensiones

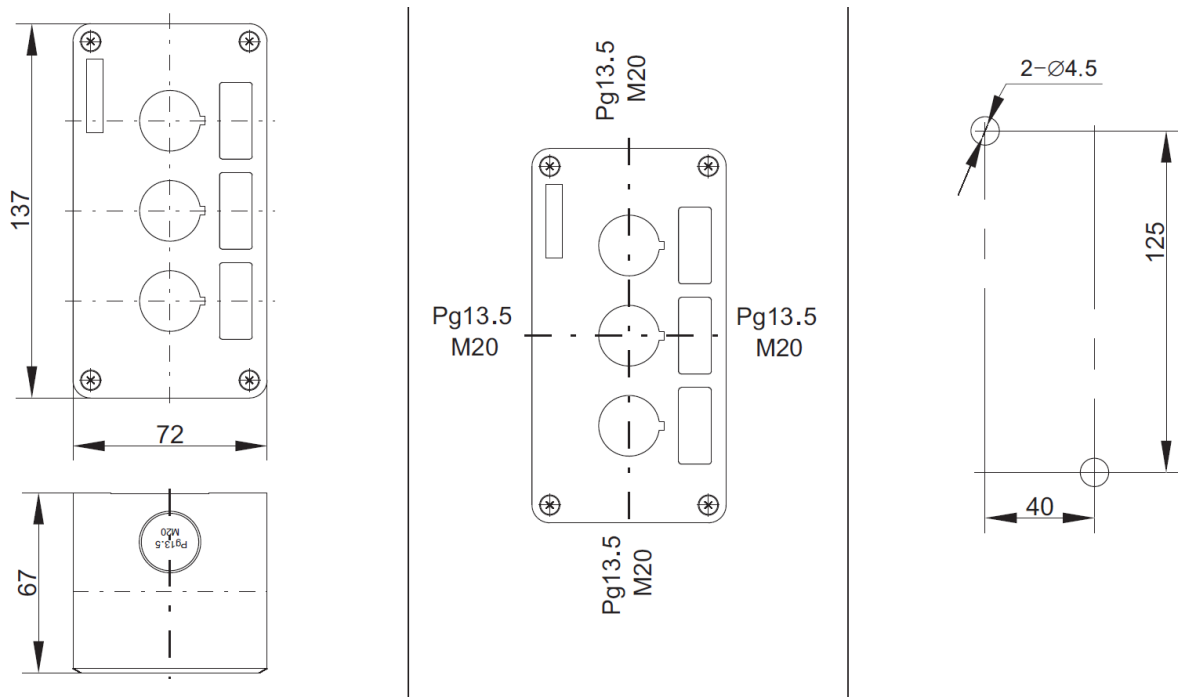

Data Sheet

Botonera gris de 4 elemento

UCB1-4-K

Norma de referencia	IEC60947-5-1:2009 GB14048.5-2008
Material	ABS
Color	Base negra y tapa gris
Temperatura de funcionamiento	ABS: -40° C ~ +80° C PC: -40° C ~ +120° C
Resistencia al fuego	ABS: V0 PC: V2
Grado de protección IP	IP65
Cubierta	Opaca, fijación con tornillo
Huecos 22mm	4



Dimensiones

